

HOLOGIC®

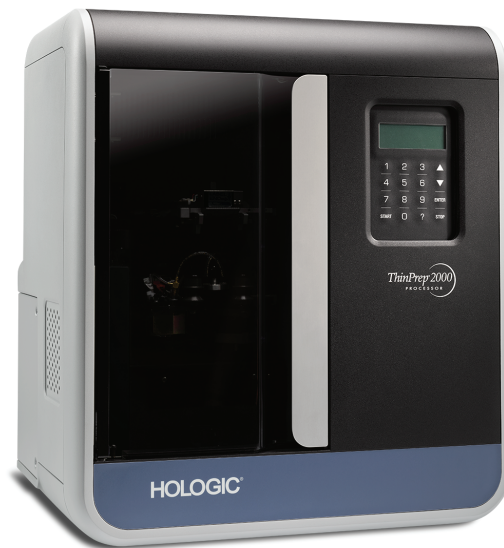

ThinPrep® 2000 Processor

Operator's Manual



ThinPrep® 2000 System Operator's Manual

HOLOGIC®



Hologic, Inc.
250 Campus Drive
Marlborough, MA 01752 USA
Tel: 1-800-442-9892
1-508-263-2900
Fax: 1-508-229-2795
Web: www.hologic.com

EC REP

Hologic Ltd.
Heron House
Oaks Business Park
Crewe Road, Wythenshawe
Manchester, M23 9HZ, UK
Tel: +44 (0)161 946 2206

Australian Sponsor:
Hologic (Australia) Pty Ltd
Suite 402, Level 4
2 Lyon Park Road
Macquarie Park NSW 2113
Australia
Tel: 02 9888 8000

MAN-01408-001

Caution: Federal law restricts this device to sale by or on the order of a physician, or any other practitioner licensed by the law of the State in which the practitioner practices to use or order the use of the device and are trained and experienced in the use of the ThinPrep 2000 System.

Preparation of microscope slides using the ThinPrep 2000 System should be performed only by personnel who have been trained by Hologic or by organizations or individuals designated by Hologic.

Evaluation of microscope slides produced with the ThinPrep 2000 System should be performed only by cytotechnologists and pathologists who have been trained to evaluate ThinPrep prepared slides by Hologic or by organizations or individuals designated by Hologic.

© Hologic, Inc., 2017. All rights reserved. No part of this publication may be reproduced, transmitted, transcribed, stored in a retrieval system, or translated into any language or computer language, in any form, or by any means, electronic, mechanical, magnetic, optical, chemical, manual, or otherwise, without the prior written permission of Hologic, 250 Campus Drive, Marlborough, Massachusetts, 01752, United States of America.

Although this guide has been prepared with every precaution to ensure accuracy, Hologic assumes no liability for any errors or omissions, nor for any damages resulting from the application or use of this information.

This product may be covered by one or more U.S. patents identified at <http://hologic.com/patentinformation>

Hologic, CytoLyt, PreservCyt and ThinPrep are registered trademarks of Hologic, Inc. or its subsidiaries in the United States and other countries. All other trademarks are the property of their respective companies.

Caution: Changes or modifications to this unit not expressly approved by the party responsible for compliance could void the user's authority to operate the equipment.

Document number: AW-03377-001 Rev. 008
8-2017

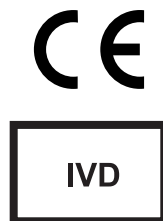

ThinPrep® 2000 System

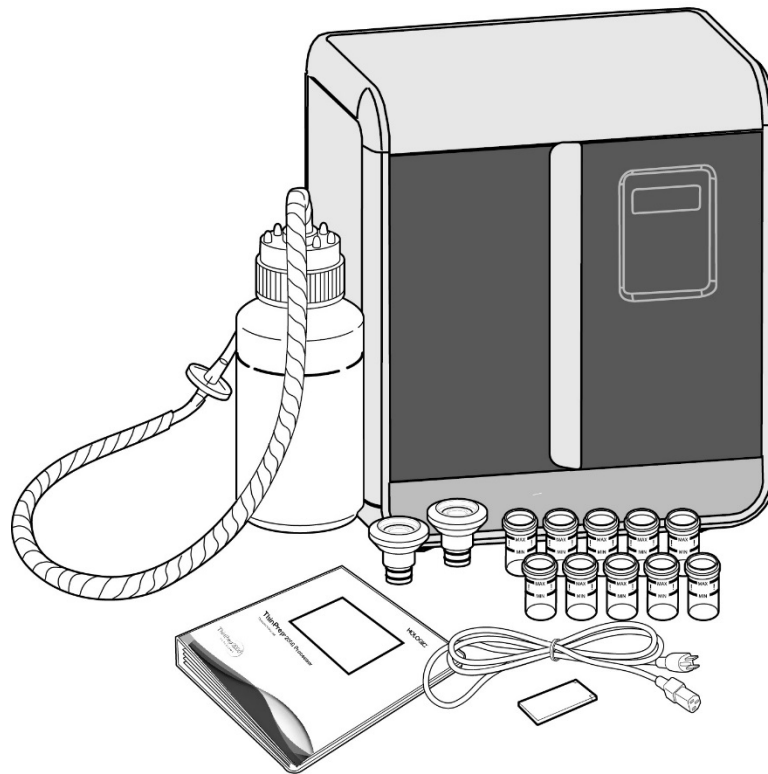

Instructions For Use

CE



INTENDED USE

The ThinPrep® 2000 System is intended as a replacement for the conventional method of Pap smear preparation for use in screening for the presence of atypical cells, cervical cancer, or its precursor lesions (Low-grade Squamous Intraepithelial Lesions, High-grade Squamous Intraepithelial Lesions), as well as all other cytologic categories as defined by *The Bethesda System for Reporting Cervical/Vaginal Cytologic Diagnoses*¹.

SUMMARY AND EXPLANATION OF THE SYSTEM

The ThinPrep process begins with the patient's gynecologic sample being collected by the clinician using a cervical sampling device which, rather than being smeared on a microscope slide, is immersed and rinsed in a vial filled with 20 ml of PreservCyt® Solution (PreservCyt). The ThinPrep sample vial is then capped, labeled, and sent to a laboratory equipped with a ThinPrep 2000 Processor.

At the laboratory, the PreservCyt sample vial is placed into a ThinPrep 2000 Processor and a gentle dispersion step breaks up blood, mucus, non-diagnostic debris, and thoroughly mixes the cell sample. The cells are then collected on a ThinPrep Pap Test Filter specifically designed to collect diagnostic cells. The ThinPrep 2000 Processor constantly monitors the rate of flow through the ThinPrep Pap Test Filter during the collection process in order to prevent the cellular presentation from being too scant or too dense. A thin layer of cells is then transferred to a glass slide in a 20 mm-diameter circle, and the slide is automatically deposited into a fixative solution.

The ThinPrep Sample Preparation Process

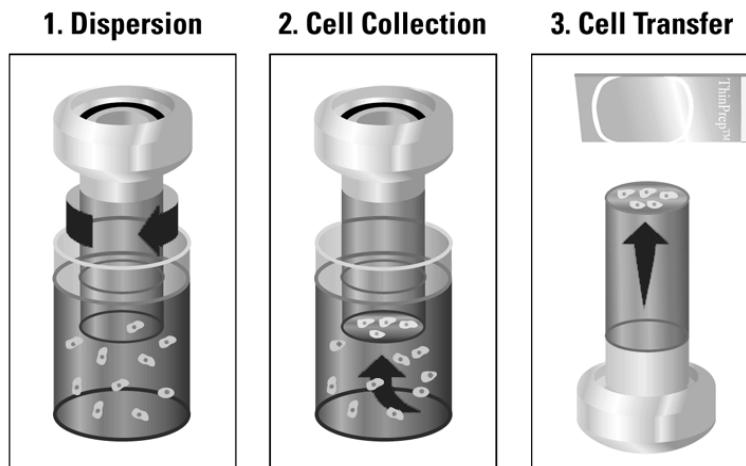

(1) Dispersion

The ThinPrep Pap Test Filter rotates within the sample vial, creating currents in the fluid that are strong enough to separate debris and disperse mucus, but gentle enough to have no adverse effect on cell appearance.

(2) Cell Collection

A gentle vacuum is created within the ThinPrep Pap Test Filter, which collects cells on the exterior surface of the membrane. Cell collection is controlled by the ThinPrep 2000 Processor's software that monitors the rate of flow through the ThinPrep Pap Test Filter.

(3) Cell Transfer

After the cells are collected on the membrane, the ThinPrep Pap Test Filter is inverted and gently pressed against the ThinPrep Microscope Slide. Natural attraction and slight positive air pressure cause the cells to adhere to the ThinPrep Microscope Slide resulting in an even distribution of cells in a defined circular area.

As with conventional Pap smears, slides prepared with the ThinPrep® 2000 System are examined in the context of the patient's clinical history and information provided by other diagnostic procedures such as colposcopy, biopsy, and human papillomavirus (HPV) testing, to determine patient management.

The PreservCyt® Solution component of the ThinPrep 2000 System is an alternative collection and transport medium for gynecologic specimens tested with the Digene Hybrid Capture™ System HPV DNA and Hologic APTIMA COMBO 2® CT/NG Assays. Refer to the respective manufacturer's package inserts for instructions for using PreservCyt Solution for collection, transport, storage, and preparation of specimens for use in those systems.

The PreservCyt Solution component of the ThinPrep 2000 System is also an alternative collection and transport medium for gynecologic specimens tested with the Roche Diagnostics COBAS AMPLICOR™ CT/NG assay. Refer to Hologic's labeling (Document #MAN-02063-001) for instructions for using PreservCyt Solution for collection, transport, storage, and preparation of specimens and to the Roche Diagnostics COBAS AMPLICOR CT/NG package insert for instructions for use of that system.

LIMITATIONS

- Gynecologic samples collected for preparation using the ThinPrep 2000 System should be collected using a broom-type or endocervical brush/plastic spatula combination collection devices. Refer to the instructions provided with the collection device for warnings, contraindications, and limitations associated with specimen collection.
- Preparation of microscope slides using the ThinPrep 2000 System should be performed only by personnel who have been trained by Hologic or by organizations or individuals designated by Hologic.
- Evaluation of microscope slides produced with the ThinPrep 2000 System should be performed only by cytotechnologists and pathologists who have been trained to evaluate ThinPrep prepared slides by Hologic or by organizations or individuals designated by Hologic.
- Supplies used in the ThinPrep 2000 System are those designed and supplied by Hologic specifically for the ThinPrep 2000 System. These include PreservCyt Solution vials, ThinPrep Pap Test Filters, and ThinPrep Microscope Slides. These supplies are required for proper performance of the system and cannot be substituted. Product performance will be compromised if other supplies are used. After use, supplies should be disposed of in accordance with local, state, and federal regulations.
- A ThinPrep Pap Test Filter must be used only once and cannot be reused.
- The performance of HPV DNA and CT/NG testing on reprocessed sample vials has not been evaluated.

WARNINGS

- For In Vitro Diagnostic Use
- Danger. PreservCyt Solution contains methanol. Toxic if swallowed. Toxic if inhaled. Causes damage to organs. Flammable liquid and vapor. Keep away from heat, sparks, open flames and hot surfaces. Other solutions cannot be substituted for PreservCyt Solution. PreservCyt Solution should be stored and disposed of in accordance with all applicable regulations.
- Do not process a cerebral spinal fluid (CSF) specimen or other sample type that is suspected of possessing prion infectivity (PrPsc) derived from a person with a TSE, such as Creutzfeldt-Jakob disease, on the ThinPrep 2000 processor. A TSE contaminated processor cannot be effectively decontaminated and therefore must be properly disposed of in order to avoid potential harm to users of the processor or service personnel.

PRECAUTIONS

- Specific processing steps must be followed before and during use of the ThinPrep 2000 processor if planning to perform *Chlamydia trachomatis* and *Neisseria gonorrhoeae* testing, using the Roche Diagnostics COBAS AMPLICOR CT/NG test, on the residual specimen after a slide has been prepared using a ThinPrep 2000 processor. Follow the procedures found in Chapter 5B of the ThinPrep 2000 Operator's Manual.
- This equipment generates, uses and can radiate radio frequency energy, and if not installed and used in accordance with the Operator's Manual, may cause interference to radio communications. Operation of this equipment in a residential area is likely to cause harmful interference, in which case the user will be required to correct the interference at his/her own expense.
- PreservCyt Solution *with* cytologic sample intended for ThinPrep Pap testing must be stored between 15°C (59°F) and 30°C (86°F) and tested within 6 weeks of collection.
- PreservCyt Solution *with* cytologic sample intended for CT/NG testing using the Roche Diagnostics COBAS AMPLICOR CT/NG test must be stored between 4°C (39°F) and 25°C (77°F) and tested within 6 weeks of collection.
- PreservCyt Solution was challenged with a variety of microbial and viral organisms. The following table presents the starting concentrations of viable organisms, and the number of viable organisms found after 15 minutes in the PreservCyt Solution. The log reduction of viable organisms is also presented. As with all laboratory procedures, universal precautions should be followed.

Organism	Initial Concentration	Log Reduction after 15 min.
Candida albicans	5.5 x 10 ⁵ CFU/mL	>4.7
Aspergillus niger*	4.8 x 10 ⁵ CFU/mL	2.7
Escherichia coli	2.8 x 10 ⁵ CFU/mL	>4.4
Staphylococcus aureus	2.3 x 10 ⁵ CFU/mL	>4.4
Pseudomonas aeruginosa	2.5 x 10 ⁵ CFU/mL	>4.4
Mycobacterium tuberculosis**	9.4 x 10 ⁵ CFU/mL	4.9
Rabbitpox virus	6.0 x 10 ⁶ PFU/mL	5.5***
HIV-1	1.0 x 10 ^{7.5} TCID ₅₀ /mL	7.0***

* After 1 hour >4.7 log reduction

** After 1 hour >5.7 log reduction

*** Data is for 5 minutes

PERFORMANCE CHARACTERISTICS: REPORT OF CLINICAL STUDIES

A prospective multi-center clinical study was conducted to evaluate the performance of the ThinPrep 2000 System in direct comparison to the conventional Pap smear. The objective of the ThinPrep clinical study was to demonstrate that gynecologic specimens prepared using the ThinPrep 2000 System were at least as effective as conventional Pap smears for the detection of atypical cells and cervical cancer or its precursor lesions in a variety of patient populations. In addition, an assessment of specimen adequacy was performed.

The initial clinical study protocol was a blinded, split sample, matched pair study, for which a conventional Pap smear was prepared first, and the remainder of the sample (the portion that normally would have been discarded) was immersed and rinsed into a vial of PreservCyt Solution. At the laboratory, the PreservCyt sample vial was placed into a ThinPrep 2000 Processor and a slide was then prepared from the patient's sample. ThinPrep and conventional Pap smear slides were examined and diagnosed independently. Reporting forms containing patient history as well as a checklist of all possible categories of The Bethesda System were used to record the results of the screening. A single independent pathologist reviewed all discrepant and positive slides from all sites in a blinded fashion to provide a further objective review of the results.

LABORATORY AND PATIENT CHARACTERISTICS

Cytology laboratories at three screening centers (designated as S1, S2, and S3) and three hospital centers (designated as H1, H2, and H3) participated in the clinical study. The screening centers in the study serve patient populations (screening populations) with rates of abnormality (Low-grade Squamous Intraepithelial Lesion [LSIL] and more severe lesions) similar to the United States average of less than 5%.² The hospital centers in the study serve a high risk referral patient population (hospital populations) characterized by high rates (>10%) of cervical abnormality. Data on race demographics was obtained for 70% of the patients that participated in the study. The study population consisted of the following race groups: Caucasian (41.2%), Asian (2.3%), Hispanic (9.7%), African American (15.2%), Native American (1.0%) and other groups (0.6%).

Table 1 describes the laboratories and the patient populations.

Table 1: Site Characteristics

Site	Laboratory Characteristics			Clinical Study Demographics			
	Type of Patient Population	Laboratory Volume - Smears per Year	Cases	Patient Age Range	Post-Meno-pausal	Previous Abnormal Pap Smear	Convent. Prevalence LSIL+
S1	Screening	300,000	1,386	18.0 - 84.0	10.6%	8.8%	2.3%
S2	Screening	100,000	1,668	18.0 - 60.6	0.3%	10.7%	2.9%
S3	Screening	96,000	1,093	18.0 - 48.8	0.0%	7.1%	3.8%
H1	Hospital	35,000	1,046	18.1 - 89.1	8.1%	40.4%	9.9%
H2	Hospital	40,000	1,049	18.1 - 84.4	2.1%	18.2%	12.9%
H3	Hospital	37,000	981	18.2 - 78.8	11.1%	38.2%	24.2%

CLINICAL STUDY RESULTS

The diagnostic categories of The Bethesda System were used as the basis of the comparison between conventional and ThinPrep® findings from the clinical study. The diagnostic classification data and statistical analyses for all clinical sites are presented in Tables 2 through 11. Cases with incorrect paperwork, patient's age less than 18 years, cytologically unsatisfactory slides, or patients with a hysterectomy were excluded from this analysis. Few cases of cervical cancer (0.02%³) were represented in the clinical study, as is typical in the United States patient population.

Table 2: Diagnostic Classification Table, All Categories

		Conventional							TOTAL
		NEG	ASCUS	AGUS	LSIL	HSIL	SQ CA	GL CA	
ThinPrep	NEG	5224	295	3	60	11	0	0	5593
	ASCUS	318	125	2	45	7	0	0	497
	AGUS	13	2	3	0	1	0	1	20
	LSIL	114	84	0	227	44	0	0	469
	HSIL	11	15	0	35	104	2	0	167
	SQ CA	0	0	0	0	0	1	0	1
	GL CA	0	0	0	0	0	0	0	0
	TOTAL	5680	521	8	367	167	3	1	6747

Abbreviations for Diagnoses: *NEG* = Normal or negative, *ASCUS* = Atypical Squamous Cells of Undetermined Significance, *AGUS* = Atypical Glandular Cells of Undetermined Significance, *LSIL* = Low-grade Squamous Intraepithelial Lesion, *HSIL* = High-grade Squamous Intraepithelial Lesion, *SQ CA* = Squamous Cell Carcinoma, *GL CA* = Glandular Cell Adenocarcinoma

Table 3: Three Category Diagnostic Classification Table

		Conventional			TOTAL
		NEG	ASCUS/AGUS+	LSIL+	
ThinPrep	NEG	5224	298	71	5593
	ASCUS/AGUS+	331	132	54	1154
	LSIL+	125	99	413	637
	TOTAL	5680	529	538	6747

Table 4: Two Category Diagnostic Classification Table, LSIL and More Severe Diagnoses

		Conventional		TOTAL
		NEG/ASCUS/AGUS+	LSIL+	
ThinPrep	NEG/ASCUS/AGUS+	5985	125	6110
	LSIL+	224	413	637
	TOTAL	6209	538	6747

Table 5: Two Category Diagnostic Classification Table, ASCUS/AGUS and More Severe Diagnoses

		NEG	ASCUS/AGUS+	TOTAL
ThinPrep	NEG	5224	369	5593
	ASCUS/AGUS+	456	698	1154
	TOTAL	5680	1067	6747

The diagnostic data analysis from the sites is summarized in Table 6 and 7. When the p-value is significant (p < 0.05), the method favored is indicated in the tables.

Table 6: Results by Site, LSIL and More Severe Lesions

Site	Cases	ThinPrep LSIL+	Convent. LSIL+	Increased Detection*	p-Value	Method Favored
S1	1,336	46	31	48%	0.027	ThinPrep
S2	1,563	78	45	73%	<0.001	ThipPrep
S3	1,058	67	40	68%	<0.001	ThinPrep
H1	971	125	96	30%	<0.001	ThinPrep
H2	1,010	111	130	(15%)	0.135	Neither
H3	809	210	196	7%	0.374	Neither

$$*Increased\ detection = \frac{ThinPrep^{\circledR}\ LSIL+ - Conventional\ LSIL+}{Conventional\ LSIL+} \times 100\%$$

For LSIL and more severe lesions, the diagnostic comparison statistically favored the ThinPrep[®] method at four sites and was statistically equivalent at two sites.

Table 7: Results by Site, ASCUS/AGUS and More Severe Lesions

Site	Cases	ThinPrep ASCUS+	Convent. ASCUS+	Increased Detection*	p-Value	Method Favored
S1	1,336	117	93	26%	0.067	Neither
S2	1,563	124	80	55%	<0.001	ThinPrep
S3	1,058	123	81	52%	<0.001	ThinPrep
H1	971	204	173	18%	0.007	ThinPrep
H2	1,010	259	282	(8%)	0.360	Neither
H3	809	327	359	(9%)	0.102	Neither

$$*Increased\ detection = \frac{ThinPrep\ ASCUS+ - Conventional\ ASCUS+}{Conventional\ ASCUS+} \times 100\%$$

For ASCUS/AGUS and more severe lesions, the diagnostic comparison statistically favored the ThinPrep method at three sites and was statistically equivalent at three sites.

One pathologist served as an independent reviewer for the six clinical sites, receiving both slides from cases where the two methods were either abnormal or discrepant. Since a true reference cannot be determined in such studies and therefore true sensitivity cannot be calculated, the use of an expert cytologic review provides an alternative to histologic confirmation by biopsy or human papillomavirus (HPV) testing as a means for determining the reference diagnosis.

The reference diagnosis was the more severe diagnosis from either of the ThinPrep or conventional Pap slides as determined by the independent pathologist. The number of slides diagnosed as abnormal at each site, compared to the reference diagnosis of the independent pathologist, provides the proportion of LSIL or more severe lesions (Table 8) and the proportion of ASCUS/AGUS or more severe lesions (Table 9). The statistical analysis allows a comparison of the two methods and a determination of which method is favored when using the independent pathologist for expert cytologic review as the adjudicator of the final diagnosis.

Table 8: Independent Pathologist Results by Site, LSIL and More Severe Lesions

Site	Cases Positive by Independent Pathologist	ThinPrep Positive	Conventional Positive	p-Value	Method Favored
S1	50	33	25	0.170	Neither
S2	65	48	33	0.042	ThinPrep
S3	77	54	33	<0.001	ThinPrep
H1	116	102	81	<0.001	ThinPrep
H2	115	86	90	0.876	Neither
H3	126	120	112	0.170	Neither

For LSIL and more severe lesions, the diagnostic comparison statistically favored the ThinPrep method at three sites and was statistically equivalent at three sites.

Table 9: Independent Pathologist Results by Site, ASCUS/AGUS and More Severe Lesions

Site	Cases Positive by Independent Pathologist	ThinPrep® Positive	Conventional Positive	p-Value	Method Favored
S1	92	72	68	0.900	Neither
S2	101	85	59	0.005	ThinPrep
S3	109	95	65	<0.001	ThinPrep
H1	170	155	143	0.237	Neither
H2	171	143	154	0.330	Neither
H3	204	190	191	1.000	Neither

For ASCUS/AGUS and more severe lesions, the diagnostic comparison statistically favored the ThinPrep method at two sites and was statistically equivalent at four sites.

Table 10 below shows the summary for all sites of the descriptive diagnosis for all Bethesda System categories.

Table 10: Summary of Descriptive Diagnosis

Descriptive Diagnosis <i>Number of Patients: 6747</i>	ThinPrep		Conventional	
	N	%	N	%
Benign Cellular Changes:	1592	23.6	1591	23.6
Infection:				
Trichomonas Vaginalis	136	2.0	185	2.7
Candida spp.	406	6.0	259	3.8
Coccobacilli	690	10.2	608	9.0
Actinomyces spp.	2	0.0	3	0.0
Herpes	3	0.0	8	0.1
Other	155	2.3	285	4.2
Reactive Cellular Changes Associated with:				
Inflammation	353	5.2	385	5.7
Atrophic Vaginitis	32	0.5	48	0.7
Radiation	2	0.0	1	0.0
Other	25	0.4	37	0.5
Epithelial Cell Abnormalities:	1159	17.2	1077	16.0
Squamous Cell:				
ASCUS	501	7.4	521	7.7
favor reactive	128	1.9	131	1.9
favor neoplastic	161	2.4	140	2.1
undetermined	213	3.2	250	3.7
LSIL	469	7.0	367	5.4
HSIL	167	2.5	167	2.5
Carcinoma	1	0.0	3	0.0
Glandular Cell:				
Benign Endometrial cells in Postmenopausal Women	7	0.1	10	0.1
Atypical Glandular Cells (AGUS)	21	0.3	9	0.1
favor reactive	9	0.1	4	0.1
favor neoplastic	0	0.0	3	0.0
undetermined	12	0.2	2	0.0
Endocervical Adenocarcinoma	0	0.0	1	0.0

Note: Some patients had more than one diagnostic subcategory.

Table 11 shows the rates of detection for infection, reactive changes, and the total benign cellular changes for both the ThinPrep® and conventional methods at all sites.

Table 11: Benign Cellular Changes Results

	ThinPrep		Conventional	
	N	%	N	%
Benign Cellular Changes				
Infection	1392	20.6	1348	20.0
Reactive Changes	412	6.1	471	7.0
Total*	1592	23.6	1591	23.6

* Total includes some patients that may have had both an infection and reactive cellular change.

Tables 12, 13, and 14 show the specimen adequacy results for the ThinPrep method and conventional smear method for all of the study sites. Of the 7,360 total patients enrolled, 7,223 are included in this analysis. Cases with patient's age less than 18 years or patients with a hysterectomy were excluded from this analysis.

Two additional clinical studies were conducted to evaluate specimen adequacy results when samples were deposited directly into the PreservCyt® vial, without first making a conventional Pap smear. This specimen collection technique is the intended use for the ThinPrep 2000 System. Tables 15 and 16 present the split sample and direct to vial results.

Table 12: Summary of Specimen Adequacy Results

Specimen Adequacy <i>Number of Patients: 7223</i>	ThinPrep		Conventional	
	N	%	N	%
Satisfactory	5656	78.3	5101	70.6
Satisfactory for Evaluation but Limited by:	1431	19.8	2008	27.8
Air-Drying Artifact	1	0.0	136	1.9
Thick Smear	9	0.1	65	0.9
Endocervical Component Absent	1140	15.8	681	9.4
Scant Squamous Epithelial Component	150	2.1	47	0.7
Obscuring Blood	55	0.8	339	4.7
Obscuring Inflammation	141	2.0	1008	14.0
No Clinical History	12	0.2	6	0.1
Cytolysis	19	0.3	119	1.6
Other	10	0.1	26	0.4
Unsatisfactory for Evaluation:	136	1.9	114	1.6
Air-Drying Artifact	0	0.0	13	0.2
Thick Smear	0	0.0	7	0.1
Endocervical Component Absent	25	0.3	11	0.2
Scant Squamous Epithelial Component	106	1.5	47	0.7
Obscuring Blood	23	0.3	58	0.8
Obscuring Inflammation	5	0.1	41	0.6
No Clinical History	0	0.0	0	0.0
Cytolysis	0	0.0	4	0.1
Other	31	0.4	9	0.1

Note: Some patients had more than one subcategory.

Table 13: Specimen Adequacy Results

		Conventional			
		SAT	SBLB	UNSAT	TOTAL
ThinPrep	SAT	4316	1302	38	5656
	SBLB	722	665	44	1431
	UNSAT	63	41	32	136
	TOTAL	5101	2008	114	7223

SAT=Satisfactory, SBLB=Satisfactory But Limited By, UNSAT=Unsatisfactory

Table 14: Specimen Adequacy Results by Site

Site	Cases	Thin Prep SAT Cases	Con-vent. SAT Cases	Thin Prep SBLB Cases	Con-vent. SBLB Cases	Thin Prep UNSAT Cases	Con-vent. UNSAT Cases
S1	1,386	1092	1178	265	204	29	4
S2	1,668	1530	1477	130	178	8	13
S3	1,093	896	650	183	432	14	11
H1	1,046	760	660	266	375	20	11
H2	1,049	709	712	323	330	17	7
H3	981	669	424	264	489	48	68
All Sites	7,223	5656	5101	1431	2008	136	114

The Satisfactory But Limited By (SBLB) category can be broken down into many subcategories, one of which is the absence of Endocervical Component. Table 15 shows the Satisfactory But Limited By category “No ECC’s” for ThinPrep® and conventional slides.

Table 15: Specimen Adequacy Results by Site, SBLB Rates for no Endocervical Component.

SBLB Due to No ECC’s					
Site	Cases	ThinPrep SBLB-no ECC’s	ThinPrep SBLB-no ECC’s (%)	Conventional SBLB-no ECC’s	Conventional SBLB-no ECC’s (%)
S1	1,386	237	17.1%	162	11.7%
S2	1,668	104	6.2%	73	4.4%
S3	1,093	145	13.3%	84	7.7%
H1	1,046	229	21.9%	115	11.0%
H2	1,049	305	29.1%	150	14.3%
H3	981	120	12.2%	97	9.9%
All Sites	7,223	1140	15.8%	681	9.4%

For the results of the clinical study involving a split-sample protocol, there was a 6.4 percent difference between conventional and ThinPrep methods in detecting endocervical component. This is similar to previous studies using a split sample methodology.

DIRECT-TO-VIAL ENDOCERVICAL COMPONENT (ECC) STUDIES

For the intended use of the ThinPrep® 2000 System, the cervical sampling device will be rinsed directly into a PreservCyt® vial, rather than splitting the cellular sample. It was expected that this would result in an increase in the pick-up of endocervical cells and metaplastic cells. To verify this hypothesis, two studies were performed using the direct-to-vial method and are summarized in Table 16. Overall, no difference was found between ThinPrep and conventional methods in these two studies.

Table 16: Summary of Direct-to-vial Endocervical Component (ECC) Studies

Study	Number of Evaluable Patients	SBLB due to No Endocervical Component	Comparable Conventional Pap Smear Percentage
Direct-to-Vial Feasibility	299	9.36%	9.43% ¹
Direct-to-Vial Clinical Study	484	4.96%	4.38% ²

1. Direct-to-Vial Feasibility study compared to overall clinical investigation conventional Pap smear SBLB-No Endocervical Component rate.

2. Direct-to-Vial Clinical study compared to site S2 clinical investigation conventional Pap smear SBLB-No Endocervical Component rate.

DIRECT-TO-VIAL HSIL+ STUDY

Following initial FDA approval of the ThinPrep System, Hologic conducted a multi-site direct-to-vial clinical study to evaluate the ThinPrep 2000 System versus conventional Pap smear for the detection of High Grade Squamous Intraepithelial and more severe lesions (HSIL+). Two types of patient groups were enrolled in the trial from ten (10) leading academic hospitals in major metropolitan areas throughout the United States. From each site, one group consisted of patients representative of a routine Pap test screening population and the other group made up of patients representative of a referral population enrolled at the time of colposcopic examination. The ThinPrep specimens were collected prospectively and compared against a historical control cohort. The historical cohort consisted of data collected from the same clinics and clinicians (if available) used to collect the ThinPrep specimens. These data were collected sequentially from patients seen immediately prior to the initiation of the study.

The results from this study showed a detection rate of 511 / 20,917 for the conventional Pap smear versus 399 / 10,226 for the ThinPrep slides. For these clinical sites and these study populations, this indicates a 59.7% increase in detection of HSIL+ lesions for the ThinPrep specimens. These results are summarized in Table 17.

Table 17: Summary of Direct-to-Vial HSIL+ Study

Site	Total CP (n)	HSIL+	Percent (%)	Total TP (n)	HSIL+	Percent (%)	Percent Change (%)
S1	2,439	51	2.1	1,218	26	2.1	+2.1
S2	2,075	44	2.1	1,001	57	5.7	+168.5
S3	2,034	7	0.3	1,016	16	1.6	+357.6
S4	2,043	14	0.7	1,000	19	1.9	+177.3
S5	2,040	166	8.1	1,004	98	9.8	+20.0
S6	2,011	37	1.8	1,004	39	3.9	+111.1
S7	2,221	58	2.6	1,000	45	4.5	+72.3
S8	2,039	61	3.0	983	44	4.5	+49.6
S9	2,000	4	0.2	1,000	5	0.5	+150.0
S10	2,015	69	3.4	1,000	50	5.0	+46.0
Total	20,917	511	2.4	10,226	399	3.9	59.7(p<0.001)

Percent Change (%) = ((TP HSIL+/TP Total)/(CP HSIL+/CP Total)-1) *100

GLANDULAR DISEASE DETECTION – PUBLISHED STUDIES

The detection of endocervical glandular lesions is an essential function of the Pap test. However, abnormal glandular cells in the Pap sample may also originate from the endometrium or from extrauterine sites. The Pap test is not intended to be a screening test for such lesions.

When suspected glandular abnormalities are identified, their accurate classification as true glandular versus squamous lesions is important for proper evaluation and subsequent treatment (*e.g.* choice of excisional biopsy method versus conservative follow-up). Multiple peer-reviewed publications⁴⁻⁹ report on the improved ability of the ThinPrep 2000 System to detect glandular disease versus the conventional Pap smear. Although these studies do not consistently address sensitivity of different Pap testing methods in detecting specific types of glandular disease, the reported results are consistent with more frequent biopsy confirmation of abnormal glandular findings by the ThinPrep Pap Test compared to conventional cytology.

Thus, the finding of a glandular abnormality on a ThinPrep Pap Test slide merits increased attention for definitive evaluation of potential endocervical or endometrial pathology.

CONCLUSIONS

The ThinPrep® 2000 System is as effective as the conventional Pap smear in a variety of patient populations and may be used as a replacement for the conventional Pap smear method for the detection of atypical cells, cervical cancer, or its precursor lesions, as well as all other cytologic categories as defined by The Bethesda System.

The ThinPrep 2000 System is significantly more effective than the conventional Pap smear for the detection of Low-grade Squamous Intraepithelial (LSIL) and more severe lesions in a variety of patient populations.

Specimen quality with the ThinPrep 2000 System is significantly improved over that of conventional Pap smear preparation in a variety of patient populations.

MATERIALS REQUIRED

MATERIALS PROVIDED

The ThinPrep 2000 System consists of the following components:

- ThinPrep Processor Instrument (Model TP 2000)
- PreservCyt® Solution vial
- ThinPrep Pap Test Filter for Gynecologic Applications
- Program Memory Card for Gynecologic Applications
- Waste bottle assembly - includes bottle, bottle cap, tubing set, fittings, waste filter
- 2 filter Caps
- 2 spare filter seal O-rings
- Power cord
- ThinPrep Microscope slides

Additional items supplied:

- ThinPrep 2000 Operator's Manual
- 10 fixative vials

MATERIALS REQUIRED BUT NOT PROVIDED

- Slide staining system and reagents
- Standard laboratory fixative
- Coverslips and mounting media
- 20 ml PreservCyt® Solution vial
- ThinPrep® Pap Test Filter for Gynecologic Applications
- Cervical collection device

STORAGE

- Store PreservCyt Solution between 15°C (59°F) and 30°C (86°F). Do not use beyond the expiration date printed on the container.
- Store PreservCyt Solution with cytologic sample intended for ThinPrep Pap testing between 15°C (59°F) and 30°C (86°F) for up to 6 weeks.
- Store PreservCyt Solution with cytologic sample intended for CT/NG testing using the Roche Diagnostics COBAS AMPLICOR CT/NG test between 4°C (39°F) and 25°C (77°F) for up to 6 weeks.

BIBLIOGRAPHY

1. Solomon D., Davey D, Kurman R, Moriarty A, O'Connor D, Prey M, Raab S, Sherman M, Wilbur D, Wright T, Young N, for the Forum Group Members and the 2001 Bethesda Workshop. The 2001 Bethesda System Terminology for Reporting Results of Cervical Cancer. *JAMA*. 2002;287:2114-2119.
2. Jones HW. Impact of The Bethesda System, *Cancer* 77 pp. 1914-1918, 1995.
3. American Cancer Society. *Cancer Facts and Figures*, 1995.
4. Ashfaq R, Gibbons D, Vela C, Saboorian MH, Iliya F. ThinPrep Pap Test. Accuracy for glandular disease. *Acta Cytol* 1999; 43: 81-5
5. Bai H, Sung CJ, Steinhoff MM: ThinPrep Pap Test promotes detection of glandular lesions of the endocervix. *Diagn Cytopathol* 2000;23:19-22
6. Carpenter AB, Davey DD: ThinPrep Pap Test: Performance and biopsy follow-up un a university hospital. *Cancer Cytopathology* 1999; 87: 105-12
7. Guidos BJ, Selvaggi SM. Detection of endometrial adenocarcinoma with the ThinPrep Pap test. *Diagn Cytopathol* 2000; 23: 260-5
8. Schorge JO, Hossein Saboorian M, Hynan L, Ashfaq R. ThinPrep detection of cervical and endometrial adenocarcinoma: A retrospective cohort study. *Cancer Cytopathology* 2002; 96: 338-43
9. Wang N, Emancipator SN, Rose P, Rodriguez M, Abdul-Karim FW. Histologic follow-up of atypical endocervical cells. Liquid-based, thin-layer preparation vs. conventional Pap smear. *Acta Cytol* 2002; 46: 453-7

TECHNICAL SERVICE AND PRODUCT INFORMATION

For technical service and assistance related to use of the ThinPrep 2000 System, contact Hologic:

Telephone: 1-800-442-9892

Fax: 1-508-229-2795

For international or toll-free blocked calls, please contact 1-508-263-2900.

Email: info@hologic.com



Hologic, Inc.
250 Campus Drive
Marlborough, MA 01752
1-800-442-9892
www.hologic.com



Hologic Ltd.
Heron House
Oaks Business Park
Crewe Road, Wythenshawe
Manchester, M23 9HZ, UK
+44 (0)161 946 2206

©2017 Hologic, Inc. All rights reserved.
AW-03378-001 Rev. 006
8-2017

**ThinPrep 2000 System
for Gynecologic Use**

**ThinPrep 2000 System
for Gynecologic Use**



ThinPrep® 2000 System For Gynecologic Use

Section 1 (white tabs) describes the use of the ThinPrep® 2000 System for gynecologic applications. In addition, it contains all information regarding the installation, operation, and maintenance of the ThinPrep® 2000 Processor.



This page intentionally left blank.



Table of Contents

Chapter One

INTRODUCTION

SECTION A: Overview and Function of the ThinPrep® 2000 System	1.1
SECTION B: Principles of Operation	1.7
SECTION C: ThinPrep 2000 System Technical Specifications	1.12
SECTION D: Internal Quality Control	1.16
SECTION E: ThinPrep 2000 Hazards	1.16
SECTION F: Disposal	1.19

Chapter Two

THINPREP 2000 INSTALLATION

SECTION A: General	2.1
SECTION B: Action Upon Delivery	2.1
SECTION C: Preparation Prior to Installation	2.2
SECTION D: Internal Packaging Removal	2.2
SECTION E: Connecting the Waste Bottle	2.6
SECTION F: Inserting the Program Memory Card	2.7
SECTION G: Connecting the Power Cord	2.8
SECTION H: Turning On Your ThinPrep 2000 Processor	2.9
SECTION I: Run a Blank Sample	2.11
SECTION J: Storage and Handling - Post Installation	2.12
SECTION K: Turning Off the ThinPrep 2000 Processor	2.12

Chapter Three

PRESERVCYT SOLUTION

SECTION A: Introduction	3.1
SECTION B: PreservCyt® Solution	3.2

Chapter Four

GYNECOLOGIC SAMPLE PREPARATION

SECTION A: Introduction	4.1
SECTION B: Collection Preparation	4.2



TABLE OF CONTENTS

SECTION C: Specimen Collection	4.3
SECTION D: Special Precautions	4.5
SECTION E: Specimen Processing	4.6
SECTION F: Sample Processing Troubleshooting	4.7

Chapter Five A

OPERATING INSTRUCTIONS

SECTION A: Introduction	5A.1
SECTION B: Optional Instructions for Ancillary Testing	5A.2
SECTION C: Material Requirements	5A.4
SECTION D: Pre-operation Checklist	5A.5
SECTION E: Overview of Loading the ThinPrep® 2000 Processor	5A.6
SECTION F: Loading the PreservCyt Sample Vial	5A.7
SECTION G: Loading the ThinPrep Pap Test Filter	5A.8
SECTION H: Loading the ThinPrep Microscope Slide	5A.11
SECTION I: Loading the Fixative Vial	5A.14
SECTION j: Closing the Door	5A.15
SECTION K: Selecting and Initiating a Sequence	5A.16
SECTION L: Unloading the ThinPrep 2000 Processor	5A.18
SECTION M: Interrupting the Slide Preparation Process	5A.20
SECTION N: Status, Maintenance, and Test Screens	5A.21

Chapter Five B

OPERATING INSTRUCTIONS FOR PROCESSING COBAS AMPLICOR™ CT/NG SAMPLES

SECTION A: Introduction	5B.1
SECTION B: Material Requirements	5B.2
SECTION C: Pre-operation Checklist	5B.4
SECTION D: Overview of Loading the ThinPrep® 2000 Processor	5B.5
SECTION E: Preparing the Filter Caps	5B.6
SECTION F: Loading the Fixative Vial	5B.7



SECTION G: Loading the ThinPrep Pap Test Filter	5B.8
SECTION H: Loading the PreservCyt Sample Vial	5B.10
SECTION I: Loading the ThinPrep Microscope Slide	5B.11
SECTION J: Closing the Door	5B.14
SECTION K: Selecting and Initiating a Sequence	5B.15
SECTION L: Unloading the PreservCyt Sample Vial	5B.18
SECTION M: Unloading the ThinPrep Microscope Slide	5B.19
SECTION N: Unloading the Filter Assembly	5B.20
SECTION O: Interrupting the Slide Preparation Process	5B.21
SECTION P: Status, Maintenance, and Test Screens	5B.22

Chapter Six

INSTRUMENT TROUBLESHOOTING

SECTION A: Introduction	6.1
SECTION B: How to Use this Section	6.2
SECTION C: Contents	6.3
SECTION D: Error History	6.37

Chapter Seven

MAINTENANCE

SECTION A: Introduction	7.1
SECTION B: Emptying Waste Bottle	7.2
SECTION C: Filter Cap Cleaning	7.4
SECTION D: Filter Cap O-ring Lubrication	7.5
SECTION E: Filter Seal O-ring Replacement	7.6
SECTION F: Door Cleaning	7.7
SECTION G: Cap Seal Cleaning	7.9
SECTION H: General Cleaning	7.10
SECTION I: Waste Tubing Replacement	7.11
SECTION J: Waste Filter Replacement	7.16
SECTION K: Emptying and Cleaning the Catch Tray	7.18
SECTION L: Moving The ThinPrep® 2000 Processor	7.19
SECTION M: Maintenance Schedule	7.20



TABLE OF CONTENTS

Chapter Eight

FIXATION, STAINING, AND COVERSLIPPING

SECTION A: Introduction	8.1
SECTION B: Fixation	8.2
SECTION C: Staining	8.6
SECTION D: Coverslipping	8.6
SECTION E: References	8.6

Chapter Nine

THINPREP PAP TEST TRAINING PROGRAM

Index

Chapter One

Introduction

This chapter describes an overview and the principles of operation of the ThinPrep® 2000 System for gynecologic sample processing.

Note: Specific processing steps using the ThinPrep 2000 System must be followed for specimens undergoing subsequent testing for *Chlamydia trachomatis* and *Neisseria gonorrhoeae* using the Roche Diagnostics COBAS AMPLICOR™ CT/NG Test. (See Chapter 5B, “Operating Instructions for Processing COBAS AMPLICOR™ CT/NG Samples”.)

SECTION

A

OVERVIEW AND FUNCTION OF THE THINPREP® 2000 SYSTEM

The ThinPrep 2000 System is used in the processing of fluid-based gynecologic specimens for use with the ThinPrep® Pap Test. The samples are collected, processed, transferred and fixed onto microscope slides in preparation for staining, coverslipping and screening. The Processor produces thin, uniform preparations of cells on ThinPrep Microscope Slides.

Indication for Use

Intended Use

The ThinPrep 2000 System is intended as a replacement for the conventional method of Pap smear preparation for use in screening for the presence of atypical cells, cervical cancer, or its precursor lesions (Low Grade Squamous Intraepithelial Lesions, High Grade Squamous Intraepithelial Lesions), as well as all other cytologic categories as defined by The Bethesda System for Reporting Cervical/Vaginal Cytologic Diagnoses¹.

1. Nayar R, Wilbur DC. (eds). *The Bethesda System for Reporting Cervical Cytology: Definitions, Criteria, and Explanatory Notes*. 3rd ed. Cham, Switzerland: Springer: 2015

1 INTRODUCTION

Figure 1-1 The ThinPrep 2000 Processor and Waste Bottle

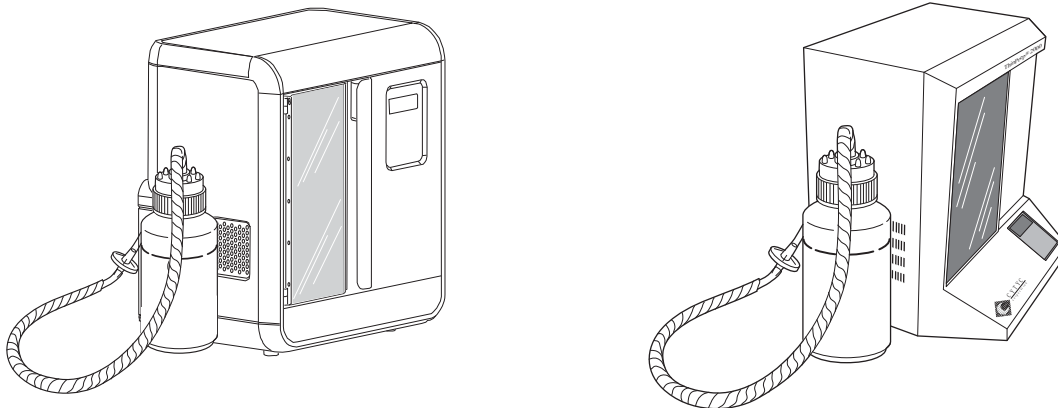

Note: In this manual, illustrations show the ThinPrep 2000 system with two different exterior appearances. This manual includes instructions for using the ThinPrep 2000 system, regardless of its exterior appearance.

Summary and Explanation of the System

The ThinPrep process begins with the patient's gynecologic sample being collected by the clinician using a cervical sampling device which, rather than being smeared on a microscope slide, is immersed and rinsed in a vial filled with PreservCyt[®] Solution. The ThinPrep sample vial is then capped, labeled, and sent to a laboratory equipped with a ThinPrep 2000 Processor.

At the laboratory, the PreservCyt sample vial is placed into a ThinPrep 2000 Processor and a gentle dispersion step breaks up blood, mucus, non-diagnostic debris, and thoroughly mixes the cell sample. The cells are then collected on a ThinPrep Pap Test Filter specifically designed to collect diagnostic cells. The ThinPrep 2000 Processor constantly monitors the rate of flow through the ThinPrep Pap Test Filter during the collection process in order to prevent the cellular presentation from being too scant or too dense. A thin layer of cells is then transferred to a glass slide in a 20mm-diameter circle. The slide is then automatically deposited into a fixative solution.

The ThinPrep Sample Preparation Process

1. Dispersion



(1) Dispersion

The ThinPrep Pap Test Filter rotates within the sample vial, creating currents in the fluid that are strong enough to separate debris and disperse mucus, but gentle enough to have no adverse effect on cell appearance.

2. Cell Collection



(2) Cell Collection

A gentle vacuum is created within the ThinPrep Pap Test Filter, which collects cells on the exterior surface of the membrane. Cell collection is controlled by the ThinPrep 2000 Processor's software that monitors the rate of flow through the ThinPrep Pap Test Filter.

3. Cell Transfer



(3) Cell Transfer

After the cells are collected on the membrane, the ThinPrep Pap Test Filter is inverted and gently pressed against the ThinPrep Microscope Slide. Natural attraction and slight positive air pressure cause the cells to adhere to the ThinPrep Microscope Slide resulting in an even distribution of cells in a defined circular area.

As with conventional Pap smears, slides prepared with the ThinPrep 2000 System are examined in the context of the patient's clinical history and information provided by other diagnostic procedures such as colposcopy, biopsy, and human papillomavirus (HPV) testing, to determine patient management.

Limitations

- Gynecologic samples collected for preparation using the ThinPrep 2000 System should be collected using a broom-type cervical collection device or endocervical brush/plastic spatula combination collection device. Refer to the instructions provided with the collection device for warnings, contraindications, and limitations associated with specimen collection.

1 INTRODUCTION

- Preparation of microscope slides using the ThinPrep 2000 System should be performed only by personnel who have been trained by Hologic or by organizations or individuals designated by Hologic.
- Evaluation of microscope slides produced with the ThinPrep 2000 System should be performed only by cytotechnologists and pathologists who have been trained to evaluate ThinPrep-prepared slides by Hologic or by organizations or individuals designated by Hologic.
- Supplies used in the ThinPrep 2000 System are those designed and supplied by Hologic specifically for the ThinPrep 2000 System. These include PreservCyt Solution vials, ThinPrep Pap Test Filters, and ThinPrep Microscope Slides. These supplies are required for proper performance of the system and cannot be substituted. Product performance will be compromised if other supplies are used. After use, supplies should be disposed of in accordance with local, state, and federal regulations.
- A ThinPrep Pap Test Filter must be used only once and cannot be reused.

Warnings

- Danger. PreservCyt Solution contains methanol. Toxic if swallowed. Toxic if inhaled. Causes damage to organs. Cannot be made non-poisonous. Consult Safety Data Sheet (SDS) at www.hologicds.com. Wear personal protective laboratory gear. Flammable liquid and vapor. Keep away from heat, sparks, open flames and hot surfaces. Evaporating alcohol could create a fire hazard. Other solutions cannot be substituted for PreservCyt Solution. PreservCyt Solution should be stored and disposed of in accordance with all applicable regulations.
- Do not process a cerebral spinal fluid (CSF) specimen or other sample type that is suspected of possessing prion infectivity (PrPsc) derived from a person with a TSE, such as Creutzfeldt-Jakob disease, on the ThinPrep 2000 processor. A TSE-contaminated processor cannot be effectively decontaminated and therefore must be properly disposed of in order to avoid potential harm to users of the processor or service personnel.
- Strong oxidizers, such as bleach, are incompatible with PreservCyt Solution and therefore should not be used to clean the waste bottle.

Precautions

- This equipment generates, uses, and can radiate radio frequency energy, and if not installed and used in accordance with the Operator's Manual, may cause interference to radio communications. Operation of this equipment in a residential area is likely to cause harmful interference, in which case the user will be required to correct the interference at his/her own expense.
- PreservCyt Solution *with* cytologic sample intended for ThinPrep Pap testing must be stored between 15°C (59° F) and 30°C (86°F) and tested within 6 weeks of collection.

- PreservCyt Solution *with* cytologic sample intended for CT/NG testing using the Roche Diagnostics COBAS AMPLICOR CT/NG test must be stored between 4°C (39° F) and 25°C (77°F) and tested within 6 weeks of collection.

PreservCyt Solution was challenged with a variety of microbial and viral organisms. The following table presents the starting concentrations of viable organisms and the number of viable organisms found after 15 minutes in the PreservCyt Solution. The log reduction of viable organisms is also presented. As with all laboratory procedures, universal precautions should be followed.

Organism	Initial Concentration	Log Reduction after 15 min.
Candida albicans	5.5 x 10 ⁵ CFU/mL	>4.7
Aspergillus niger*	4.8 x 10 ⁵ CFU/mL	2.7
Escherichia coli	2.8 x 10 ⁵ CFU/mL	>4.4
Staphylococcus aureus	2.3 x 10 ⁵ CFU/mL	>4.4
Pseudomonas aeruginosa	2.5 x 10 ⁵ CFU/mL	>4.4
Mycobacterium tuberculosis**	9.4 x 10 ⁵ CFU/mL	4.9
Rabbitpox virus	6.0 x 10 ⁶ PFU/mL	5.5***
HIV-1	1.0 x 10 ^{7.5} TCID ₅₀ /mL	7.0***

* After 1 hour >4.7 log reduction

** After 1 hour >5.7 log reduction

*** Data is for 5 minutes

MATERIALS REQUIRED

Materials Provided

The ThinPrep 2000 System Consists of the Following Components:

- ThinPrep Processor Instrument (Model: ThinPrep 2000)
- PreservCyt Solution Vial
- Gyn ThinPrep Pap Test Filter (clear)
- Program Memory Card

1 INTRODUCTION

- Power Cord
- 2 Filter Caps
- 2 spare filter seal O-rings
- Waste bottle assembly — includes bottle, bottle cap, tubing set, fittings, waste filter
- ThinPrep Microscope Slides

Additional Items Supplied:

- ThinPrep 2000 System Operator's Manual
- 10 Fixative Vials
- Cervical Collection Device
- Sealed cylinder

Materials Required But Not Provided

- Slide staining system and reagents
- Standard laboratory fixative
- Coverslips and mounting media
- Lint-free wipes

Storage

- Store PreservCyt Solution between 15° C(59° F) and 30°C (86°F). Do not use beyond the expiration date printed on the container.
- Store PreservCyt Solution *with* cytologic sample intended for ThinPrep Pap testing between 15° C (59° F) and 30°C (86°F) for up to 6 weeks.
- Store PreservCyt Solution *with* cytologic sample intended for CT/NG testing using the Roche Diagnostics COBAS AMPLICOR CT/NG test between 4°C (39° F) and 25°C (77°F) for up to 6 weeks.

SECTION
B

PRINCIPLES OF OPERATION

The ThinPrep 2000 Processor makes use of mechanical, pneumatic, and fluidic principles for cell dispersion, collection, and transfer. A rotary drive mechanism gently disperses samples. A pneumatic/fluidic system, controlled by a microprocessor, monitors cell collection. Electrochemical principles, the pneumatic and fluidic systems, the natural binding qualities of cells, and the qualities of the ThinPrep Pap Test Filter are responsible for cell transfer.

Each ThinPrep Processor slide preparation processing sequence is optimized for the biological characteristics of the various cytological specimens.

The ThinPrep Processor slide preparation process can be divided into the following phases:

- Sample preparation/Instrument loading
- Start of cycle
- Fluid level detection
- Dispersion
- Filter wetting
- Cell collection
- Waste clearing
- Bubble point
- Cell transfer
- Slide ejection
- Completion of cycle

The following sections describe the principles of each of these phases in detail.

1 INTRODUCTION

Sample Preparation/Instrument Loading

Before the ThinPrep Processor can process gynecologic samples, the samples must be placed into PreservCyt Solution. Gynecologic samples must be prepared according to the protocols described in Chapter 4, “Gynecologic Sample Preparation”. Once the cells are added to the PreservCyt Solution vial by the appropriate method, the instrument can process the sample vial.

In preparation for sample processing, the operator loads four essential items into the ThinPrep 2000 Processor: a PreservCyt Sample vial, a ThinPrep Pap Test Filter attached to the filter cap, a ThinPrep Slide and a fixative vial containing a standard laboratory fixative. The processes of loading and operating the instrument are explained in Chapter 5A, “Operating Instructions”.

Start of Cycle

When the operator initiates a sequence, the ThinPrep 2000 Processor verifies installation of disposables, motor positions, and the positive and negative pressures in the pressure reservoirs. After this the instrument processes the slide using the selected sequence.

Fluid Level Detection

The cap seal lowers to seal the filter assembly and the sample vial is raised towards the filter membrane. The sample vial stops when the filter membrane makes contact with the surface of fluid. If the fluid level is satisfactory, the instrument will continue the slide preparation process. An error message and audible alarm indicate an unsatisfactory fluid level.

Dispersion

The cap seal lifts and the dispersion system rotates the ThinPrep Pap Test Filter assembly within the cell suspension, creating shear forces in the fluid that are strong enough to separate randomly joined material and disperse mucus, and are not known to have an adverse effect on the cellular architecture or on adhesive forces joining diagnostically relevant groups of cells.

Filter Wetting

The head seal lowers to seal the filter assembly. Negative pressure is briefly applied, drawing a small amount of fluid through the ThinPrep Pap Test Filter to wet it. Following wetting, the system gently blows out the liquid in the ThinPrep Pap Test Filter. This clears any cellular material from the filter surface.

Cell Collection

The filter membrane is biologically neutral and is mounted at one end of the ThinPrep Pap Test Filter cylinder. The membrane is a flat, smooth, porous surface that collects the cellular material on one plane.

The pneumatic system applies negative pressure to the filter in a series of pulses. These negative pressure pulses (sips) draw PreservCyt Solution through the filter membrane and collect suspended cellular material onto the outer membrane surface.

The collection process ceases when a target filter coverage, predetermined by the processor sequence, is attained. Cell collection is controlled by an embedded microprocessor that monitors the pressure in the ThinPrep Pap Test Filter cylinder. After collection, the cells sit on a single plane over the pores, ready for transfer to the slide. Figure 1-2 illustrates cell collection.

Figure 1-2 Cell Collection

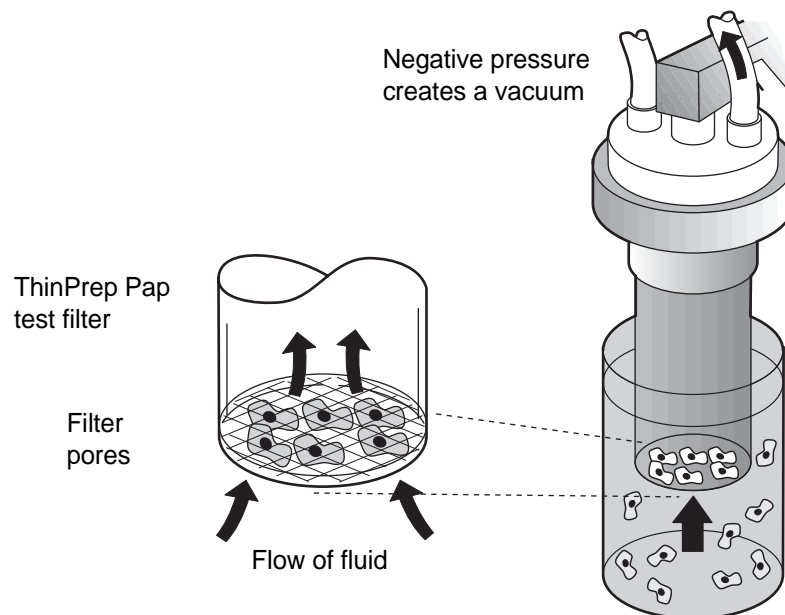

1 INTRODUCTION

Waste Clearing

When collection ends, the ThinPrep Pap Test Filter is withdrawn from the sample vial and the filtrate is aspirated into the waste bottle as the filter is inverted. The collected cells remain on the ThinPrep Pap Test Filter due to the negative holding pressure.

Bubble Point

Bubble point removes excess fluid from the filter membrane prior to transferring cells onto the slide to enhance cell adhesion to the slide.

Bubble point is performed after all of the fluid is evacuated. This is evident by the bubbling activity on the inside of the filter membrane. Cells do not air-dry during bubble point.

Cell Transfer

When bubble point is complete, the slide handler moves the slide into contact with the inverted ThinPrep Pap Test Filter.

The natural adhesion properties of cells and the electrochemical charge of the glass slide are responsible for the transfer of cells from the filter membrane to the slide. The cells have a higher affinity for the glass slide than for the membrane; slight positive air pressure behind the filter membrane enhances cell transfer.

Slide Ejection

Once cell transfer is complete, the slide is removed from contact with the filter and automatically ejected into the fixative vial.

Cycle Completion

All the motorized mechanisms return to their initial positions and the display returns to the Main Menu. If the system detects an error during the process, a message will be displayed and an audible alarm will sound.

Figure 1-3 Overview of processing.

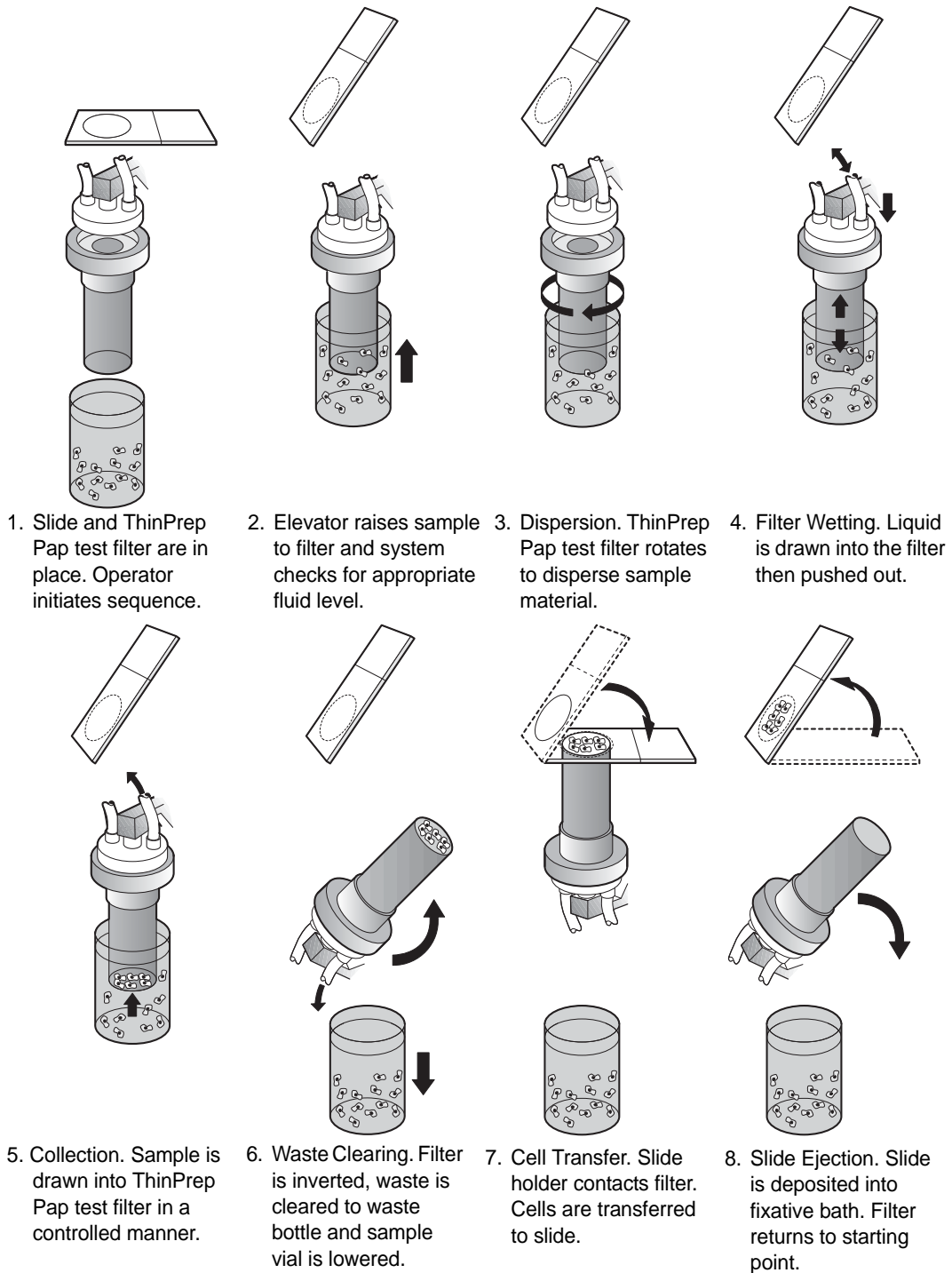

THINPREP 2000 SYSTEM TECHNICAL SPECIFICATIONS

Overview of Components

Figure 1-4 ThinPrep 2000 System Components

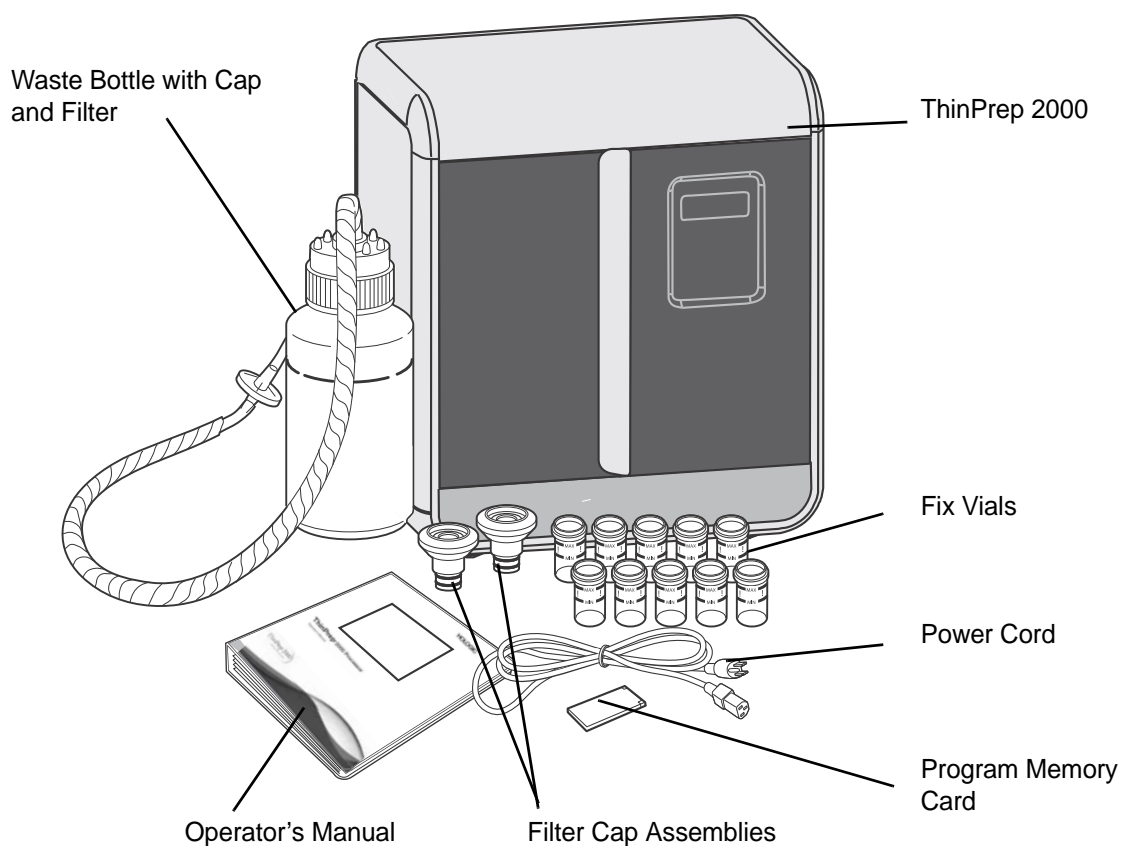

ThinPrep 2000 Dimensions and Clearances

Figure 1-5 Processor Dimensions

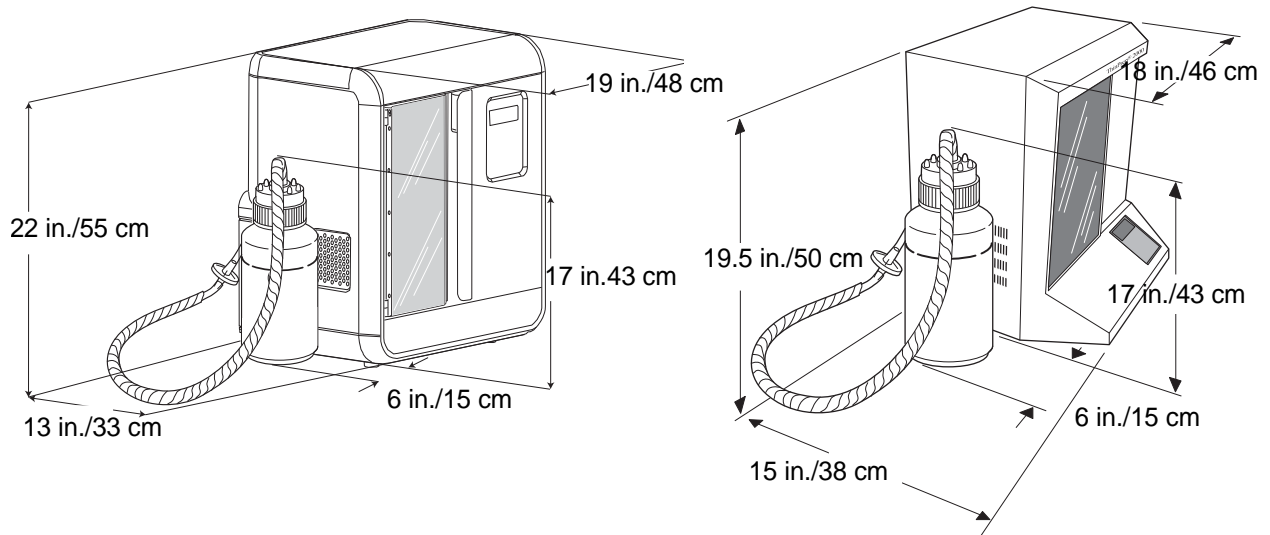
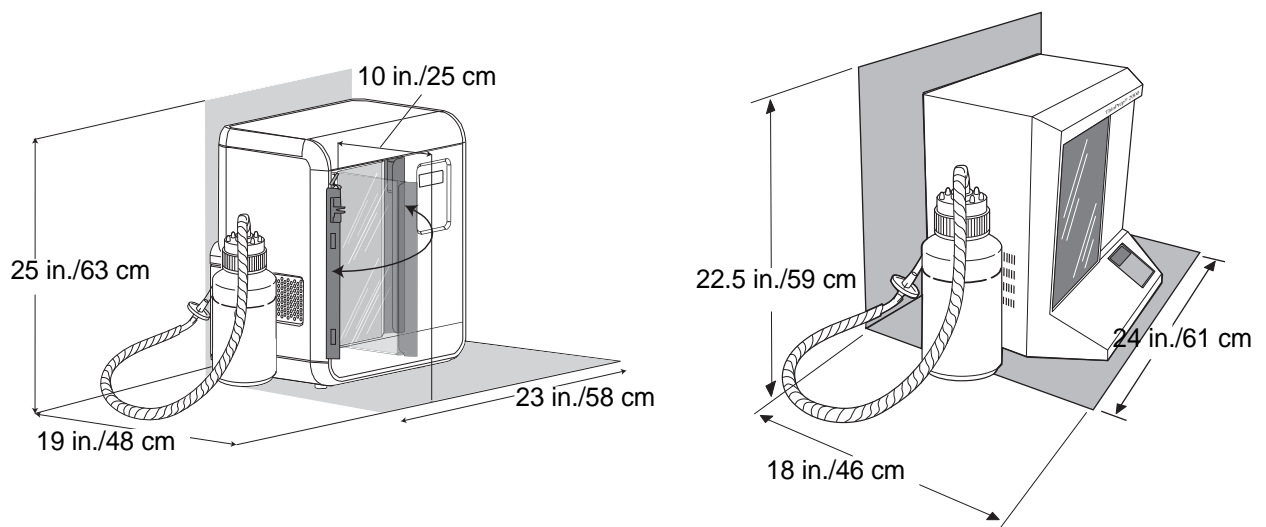

Figure 1-6 Processor Clearances





INTRODUCTION

Dimensions and Weight (Approximate)

ThinPrep Processor with hinged door: 22" / 55 cm H x 19" / 48 cm W x 13" / 33 cm D
48lbs / 21.9kg

ThinPrep Processor with sliding door: 19.5" / 50cm H x 18" / 46cm W x 15" / 38cm D
41lbs / 18.6kg

Waste Bottle: 17" / 43cm H x 6" / 15cm diameter

Environmental

Operating Temperature

15–32°C

59–90°F

Operating Humidity

20%–90% RH, non-condensing

Non-operating (Shipping and storage) Temperature

-28–50°C

-20–122°F

Pollution Degree: II, in accordance with IEC 60664.

Category II, the ThinPrep 2000 is for indoor use only in an office or a clean laboratory environment.

Altitude: 0 meters (sea level) to 2000 meters.

Atmospheric Pressure: 1100 millibar to 500 millibar.

Sound levels

Maximum A-weighted sound pressure level at the operator's position and at a bystander's position is 72.5 dBA.

Power

Electrical Voltage

100/120 VAC at 2 amps

220/240 VAC at 1 amp

Frequency Power

47–63 Hz

Maximum 200 watts

Fusing

Two 3.15A / 250V 5x20mm glass, time delay

RS-232 Connection

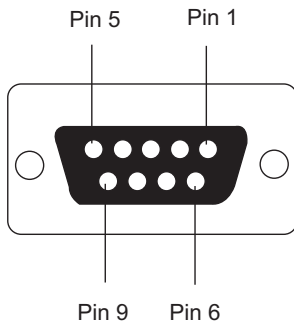

Pin	Signal	Description
1	CD	Carrier Detect
2	RD	Receive Data
3	TD	Transmit Data
4	DTR	Data Terminal Ready
5	SG	Signal Ground
6	DSR	Data Set Ready
7	RTS	Request To Send
8	CTS	Clear To Send
9	RI	Ring Indicator

ThinPrep 2000 Standards

The ThinPrep 2000 System has been tested and certified by a U.S. nationally recognized testing Laboratory (NRTL) to comply with current Safety, Electro-Magnetic Interference (EMI) and Electro-Magnetic Compatibility (EMC) standards. Refer to the processor product label, located on the rear of the instrument, to see the safety certification markings.

This equipment meets the emission and immunity requirements of IEC 61326-2-6. This equipment has been designed and tested to CISPR 11 Class A. In a domestic environment it may cause radio interference, in which case, you may need to take measures to mitigate the interference. The electro-magnetic environment should be evaluated prior to operation.

Do not use this device in close proximity to sources of strong electromagnetic radiation (e.g., unshielded intentional radio frequency sources), as these may interfere with the proper operation.

Caution: Changes or modifications to this unit not expressly approved by the party responsible for compliance could void the user's authority to operate the equipment.

This equipment has been tested and found to comply with the limits for a Class A digital device, pursuant to Part 15 of the FCC Rules. These limits are designed to provide reasonable protections against harmful interference when the equipment is operated in a commercial environment. This equipment generates, uses, and can radiate radio frequency energy; and if not installed and used in accordance with the instruction manual may cause harmful interference to radio communications. Operation of this equipment in a residential area is likely to cause harmful interference, in which case the user will be required to correct the interference at his own expense.

This product is *in vitro diagnostic* (IVD) medical equipment.

1 INTRODUCTION

SECTION D INTERNAL QUALITY CONTROL

Power On Self Test (POST)

When the ThinPrep 2000 is powered on (refer to page 2.9), the system goes through a self-diagnostic test. The electrical, mechanical and software/communications subsystems are tested to confirm that each performs properly. The operator is alerted to malfunctions by a message on the LCD display and audible beeps.

SECTION E THINPREP 2000 HAZARDS

The ThinPrep 2000 System is intended to be operated in the manner specified in this manual. Be sure to review and understand the information listed below in order to avoid harm to operators and/or damage to the instrument.

If this equipment is used in a manner not specified by the manufacturer, then the protection provided by the equipment may be impaired.

Warnings, Cautions and Notes

The terms **WARNING**, **CAUTION** and **Note** have specific meanings in this manual.

A **WARNING** advises against certain actions or situations that could result in personal injury or death.

A **CAUTION** advises against actions or situations that could damage equipment, produce inaccurate data or invalidate a procedure, although personal injury is unlikely.

A **Note** provides useful information within the context of the instructions being provided.

Symbols Used on the Instrument

The following symbols may appear on this instrument:



Attention, refer to accompanying documents.



Protective Conductor Terminal (internal use only, not accessible to operators).



Waste Electrical and Electronic Equipment - contact Hologic for disposal of the instrument.



In vitro diagnostic medical device



Authorized representative in the European Community



Manufacturer



Date of manufacture



Catalogue number



Serial number

Location of Labels Used on the Instrument

Figure 1-7 Location of Labels Used on the Instrument

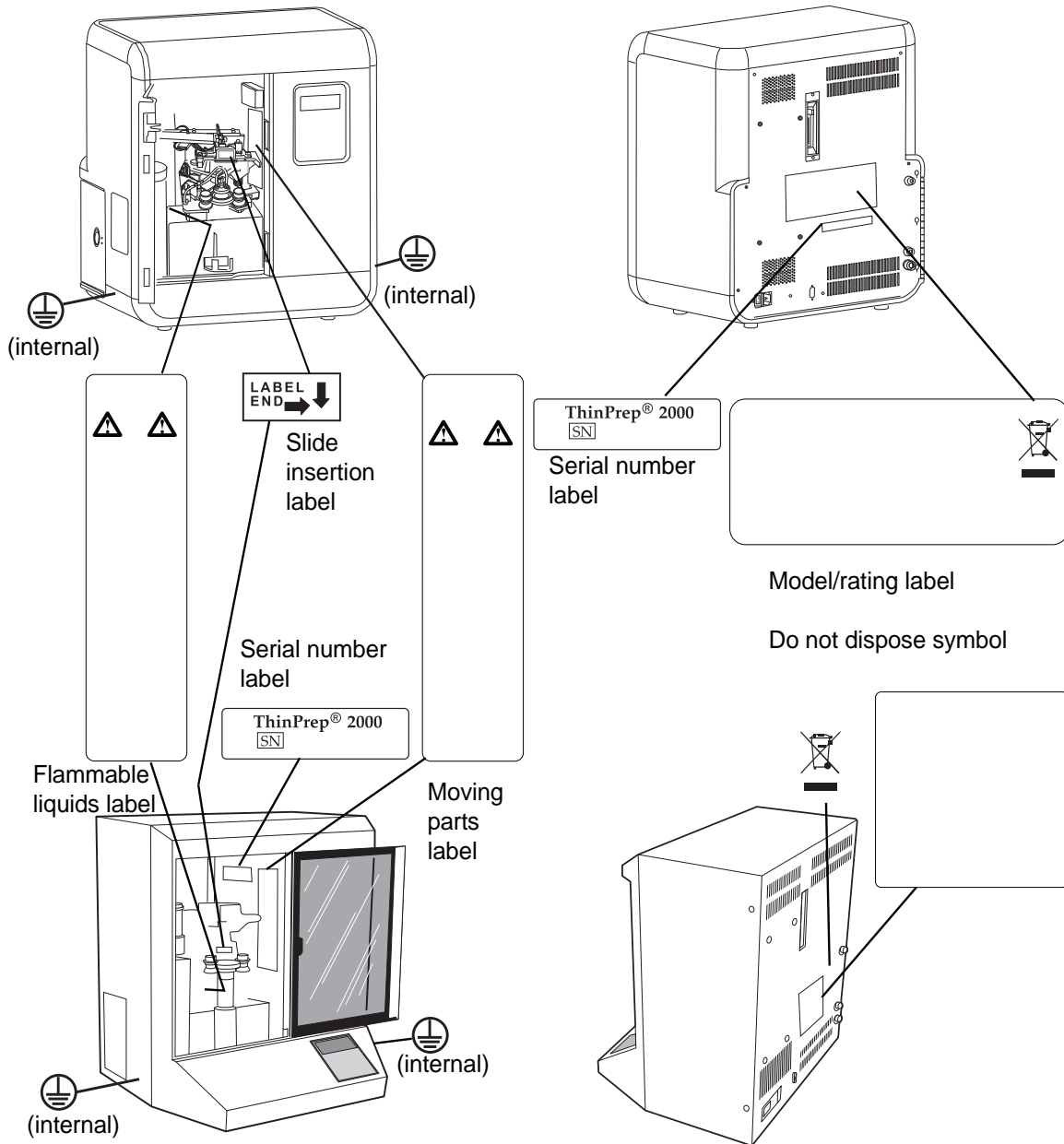

Warnings Used in this Manual:

WARNING: Moving Parts

The instrument contains moving parts. Keep hands, loose clothing, jewelry, etc., clear.

WARNING: Grounded Outlet

To ensure safe operation of the instrument, use a three-wire grounded outlet. Disconnection from the power supply source is by removal of the power cord.

WARNING: Glass

The instrument uses microscope slides, which have sharp edges. In addition, the slides may be broken in their storage packaging or on the instrument. Use caution when handling glass slides and cleaning the instrument.

WARNING: Flammable Liquid and Vapor

Flammable liquid and vapor. Keep away from heat, sparks, open flames and hot surfaces. Evaporating alcohol could create a fire hazard.

WARNING: Toxic Mixture

Danger. PreservCyt Solution contains methanol. Toxic if swallowed. Toxic if inhaled. Refer to Safety Data Sheet (SDS) at www.hologicsds.com for safe handling instructions. Wear personal protective laboratory gear.

SECTION F

DISPOSAL

Disposal of Consumable Items

- **Fix Reagent.** Follow local, state, provincial and federal or county guidelines. Dispose of all solvents as hazardous waste.
- **Waste Bottle contents.** Dispose of all solvents as hazardous waste. Follow local, state, provincial and federal or county guidelines. As with all laboratory procedures, universal precautions should be followed.
- **PreservCyt Solution.** Follow local, state, provincial and federal or county guidelines. Dispose of all solvents as hazardous waste.
- **Used Filters.** Dispose of as regular waste.
- **Base Liners (Absorbent Pads).** Dispose of as regular waste. (If dripping wet, dispose of as hazardous waste.)

1 INTRODUCTION

- **Used Filter Seal O-Rings and Filter Caps.** Dispose of as regular waste.
- **Waste Filter.** Dispose of as regular waste.
- **Pinch Valve Tubing.** Dispose of as regular waste.
- **CytoLyt Solution.** Dispose of as hazardous waste. Follow local, state, provincial and federal or county guidelines. Dispose of all solvents as hazardous waste.
- **Broken Glass.** Dispose of in a Sharps container.

Disposal of the Equipment

Waste Electrical & Electronic Equipment (WEEE)

Hologic is dedicated to meeting country specific requirements associated with the environmentally sound treatment of our products. Our objective is to reduce the waste arising from our electrical and electronic equipment. Hologic realizes the benefits of subjecting such WEEE equipment to potential reuse, treatment, recycling or recovery to minimize the amount of hazardous substances entering the environment.

Your Responsibility

As a Hologic customer, you are responsible for ensuring that devices marked with the symbol shown below are not placed into the municipal waste system unless authorized to do so by the authorities in your area. Please contact Hologic (see below) prior to disposing any electrical equipment provided by Hologic.

Symbol Used on the Instrument

The following symbol is used on this instrument:

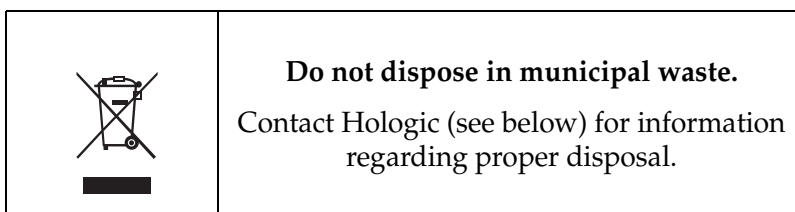

Reclamation

Hologic will provide for the collection and proper reclamation of electrical devices we provide to our customers. Hologic strives to reuse Hologic devices, subassemblies, and components whenever possible. When reuse is not appropriate, Hologic will ensure the waste material is properly disposed of.



Contact Information

Corporate Headquarters

Hologic, Inc.

250 Campus Drive

Marlborough, MA 01752 USA

Tel: (USA and Canada)

1-800-442-9892

Fax: 1-508-263-2967

Authorized European Representative

Hologic Ltd.

Heron House, Oaks Business Park

Crewe Road, Wythenshawe

Manchester, M23 9HZ, UK

Tel:+44 (0)161 946 2206



1 INTRODUCTION

This page intentionally left blank.

**2. ThinPrep 2000
Installation**

**2. ThinPrep 2000
Installation**

Chapter Two

ThinPrep 2000 Installation

SECTION A

GENERAL

This section provides information for unpacking and installing your ThinPrep® Processor. Please *completely* follow the installation procedure, step by step, to ensure proper installation and system operation.

SECTION B

ACTION UPON DELIVERY

Inspect the packing cartons for damage. Report any damage immediately to the shipper and/or Hologic Technical Support as soon as possible. (Refer to Service Information at the back of this manual.)

If the instrument will not be unpacked right away, store the equipment in a suitable environment until installation: cool, dry, vibration-free area.

Before proceeding with the installation of the ThinPrep 2000 Processor, compare the contents of the shipping container(s) with the checklist below. If any items are missing or damaged, contact Hologic Technical Support. For customers outside of the USA, please contact your Hologic distributor.

Checklist for contents of shipping container and accessory kit.

- ThinPrep 2000
- ThinPrep 2000 Operator's Manual
- Program Memory Card
- Power Cord, 6 feet (1.8 m)
- 2 Filter Caps
- 2 spare Filter Seal O-rings
- Waste Bottle Assembly — includes bottle, bottle cap, tubing set, fittings, waste filter
- 10 Fixative Vials
- #1 Tip (small) Phillips Head screwdriver
- #2 Tip (large) Phillips Head screwdriver with string attached

2

THINPREP 2000 INSTALLATION

- High vacuum silicone grease
- Base liners (absorbent pads)
- Replacement tubing for evacuation system
- Waste bottle cap for bottle transport
- Sealed cylinder for testing
- Dispenser Pump
- ThinPrep Microscope Slides 100 pack

Caution: Turning the power on before instructed to do so can damage the instrument and invalidate your warranty.

SECTION C

PREPARATION PRIOR TO INSTALLATION

Location Selection Information

Locate the ThinPrep 2000 Processor near a 3-prong grounded power outlet that is free of voltage fluctuations and power surges. As with most laboratory equipment, it may be necessary to install a line voltage stabilizer to eliminate power fluctuations and minimize interference from other systems.

During operation the ThinPrep 2000 Processor is sensitive to vibrations. It should be placed on a sturdy bench that can support the 41 lbs (18.6kg) that the instrument weighs. The bench should be away from centrifuges, vortexors, or any other equipment that may cause vibrations. If the location of the instrument must be in proximity to one of these devices, it should not be operating at the same time as any of these other devices.

Allowing for adequate clearances, the following space is required for the ThinPrep Processor:
H = 25 in./63 cm, W = 23 in./58 cm, D = 19 in./48 cm. (Refer to Figure 1-6.)

The waste bottle may be placed either on the bench with the processor or below the processor. The waste bottle will occupy an area approximately a 6 in./15 cm square by 17 in./43 cm high.

SECTION D

INTERNAL PACKAGING REMOVAL

The inside mechanism of the ThinPrep 2000 Processor is secured for shipment in two areas. A formed foam insert secures the rotating plate in a vertical position, and a small foam block secures the slide handler. These internal securements must be removed before operating the instrument. Do not turn on the power of the processor until instructed to do so.



Caution: Turning the power on before instructed to do so can damage the instrument and invalidate your warranty.

Rotating Plate Packaging Removal:

1. Open the door of the ThinPrep 2000 Processor.
2. Grasp the foam shipping insert and pull it straight forward, out of the instrument.

Note: The foam insert fits very tightly in the instrument. Use care when removing it to pull straight outward and not dislodge any of the mechanisms.

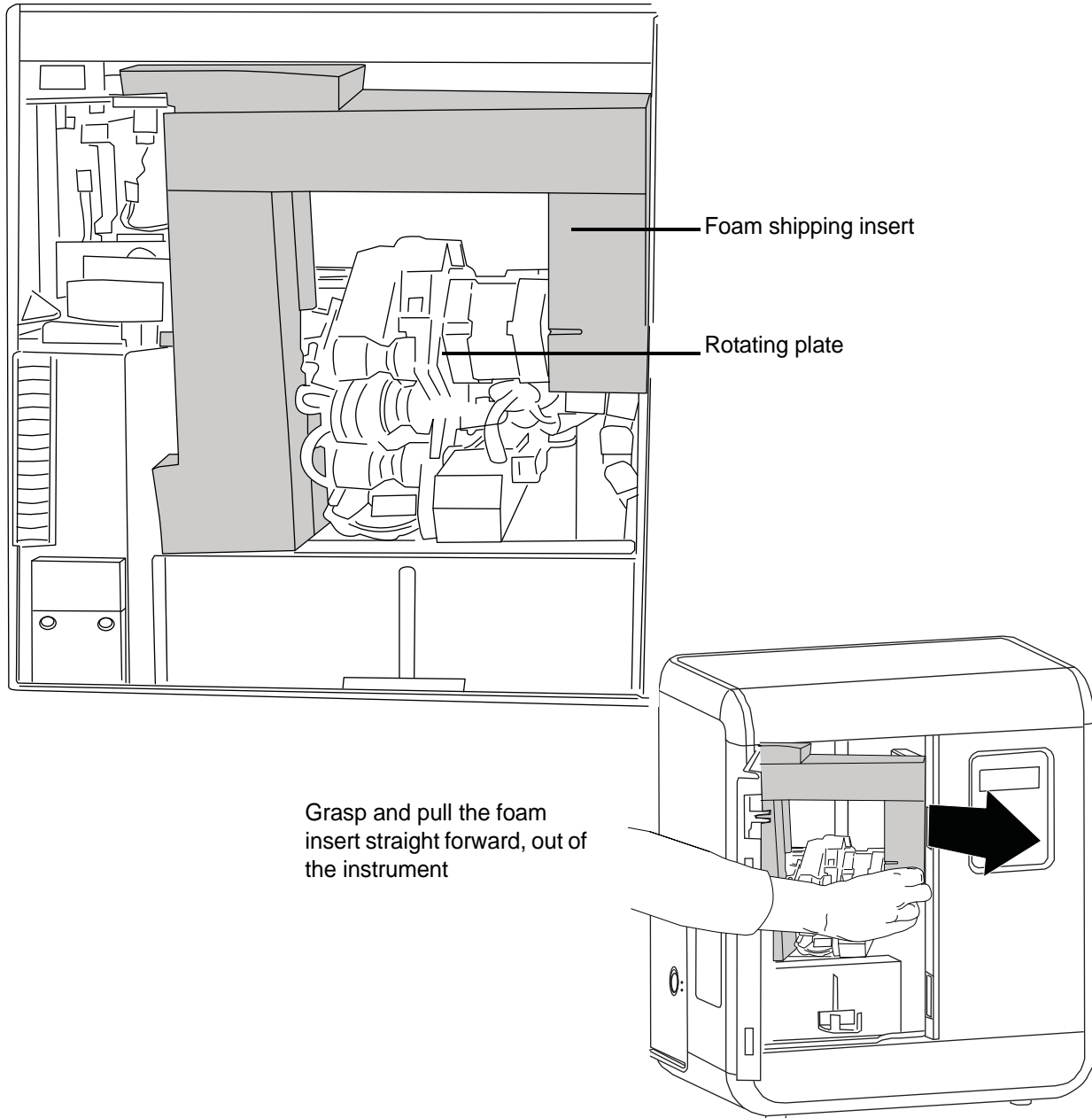
Figure 2-1 Removing the rotating plate packaging

3. The rotating plate can be turned clockwise into a horizontal position.
4. Save the foam insert for subsequent instrument packaging.

Slide Handler Packaging Removal:

1. Locate the orange foam block securing the slide handler. The slide handler is secured in the upper left-hand corner of the instrument. Refer to Figure 2-2.

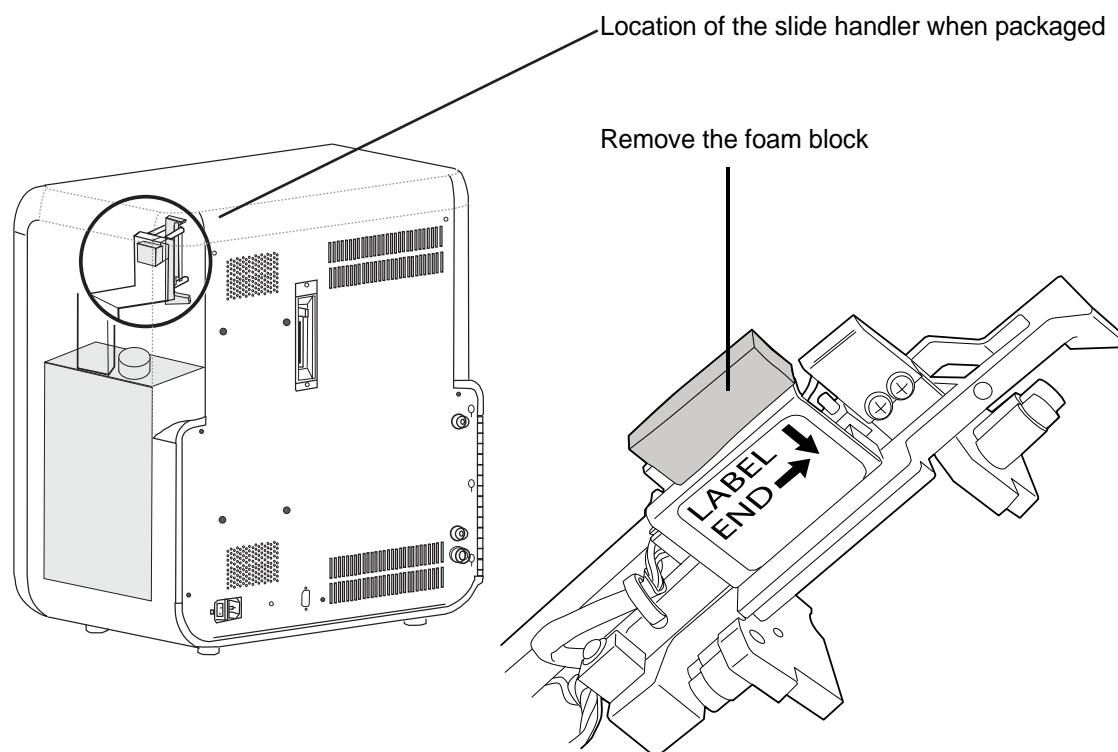
Figure 2-2 Removing the slide handler packaging

2. Carefully remove the foam block that is between the slide handler and the four horizontal ejector pins. The foam block may still be between the four ejector pins in the upper left-hand corner of the unit. The slide handler may be rotated to a horizontal position to remove the foam block.
3. Close the door.
4. Save the foam block for subsequent instrument packaging.

2

THINPREP 2000 INSTALLATION

SECTION E

CONNECTING THE WASTE BOTTLE

Caution: At no time should bleach be present in the Waste Bottle while it is connected to the ThinPrep Processor. Refer to Chapter 7, “Maintenance” for details regarding the use of bleach.

1. The waste bottle should be placed at the same height or below the ThinPrep Processor. Do not place the waste bottle above the instrument.
2. Ensure that the waste bottle cap is tightly secured. The waste bottle must rest in an upright position. Do not allow the waste bottle to lay on its side.
3. Locate the three waste bottle connections at the rear of the ThinPrep Processor. Refer to Figure 2-3. Ensure that the buttons of the connectors are in the down/inward position.

Figure 2-3 Waste Tubing Connections

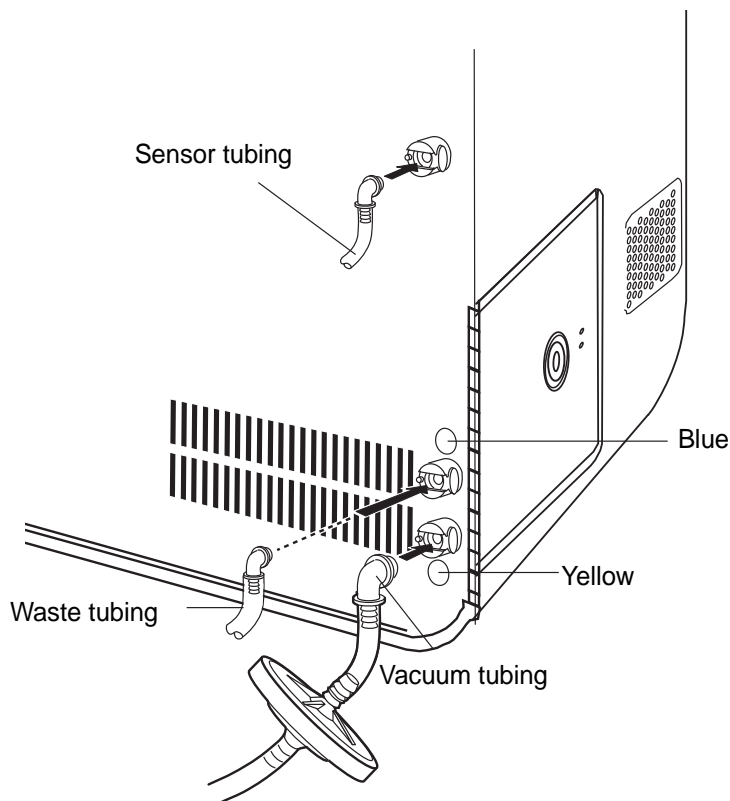

4. Connect the color-coded waste tubing connectors to the corresponding connectors located in the rear of the instrument. When the proper connection has been established, the buttons on the connectors pop up/outward with a click sound. It may be necessary to push the button in before placing the waste tubing connector into the instrument connector.

Caution: Do not attempt to mismatch tubing connection. This may result in damage to your processor.

Caution: Always empty the waste bottle before it reaches the maximum liquid level line. Follow the procedure in Chapter 7, “Maintenance”

SECTION
F

INSERTING THE PROGRAM MEMORY CARD

1. Confirm the power to the unit is off.

Caution: ALWAYS turn off the power before inserting or removing the Program Memory Card.

2. Locate the receptacle for the Program Memory Card (PMC) in the center of the rear panel of the ThinPrep 2000 Processor.
3. Orient the PMC as indicated by the arrows on the label of the card.
4. Insert the PMC into the unit as shown in Figure 2-4. Continue to insert the card until the small black button at the top of the receptacle snaps out. If the PMC does not enter the unit smoothly, do not force it into the ThinPrep 2000 Processor socket.

Figure 2-4 Inserting the Program Memory Card

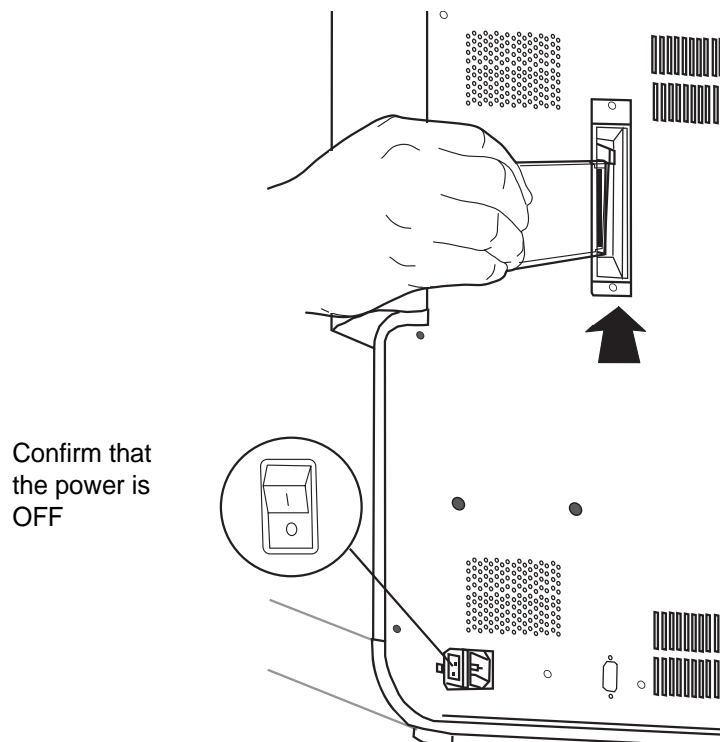

2

THINPREP 2000 INSTALLATION

5. To remove the PMC, simply depress the black button at the top of the receptacle and gently remove the PMC.

SECTION G

CONNECTING THE POWER CORD

Caution: Turning the power on before instructed to do so can damage the instrument and invalidate your warranty.

1. Ensure that the power switch, located on the rear of the ThinPrep 2000 Processor, is in the “O” (Off) position. For “Off,” the top half of the toggle power switch is in the “out” position (protrudes).
2. Insert the power cord into the power receptacle located on the rear of the ThinPrep 2000 Processor next to the power switch. Refer to Figure 2-5.
3. Connect the power cord to a 3-prong grounded outlet.

Figure 2-5 Connecting the power cord

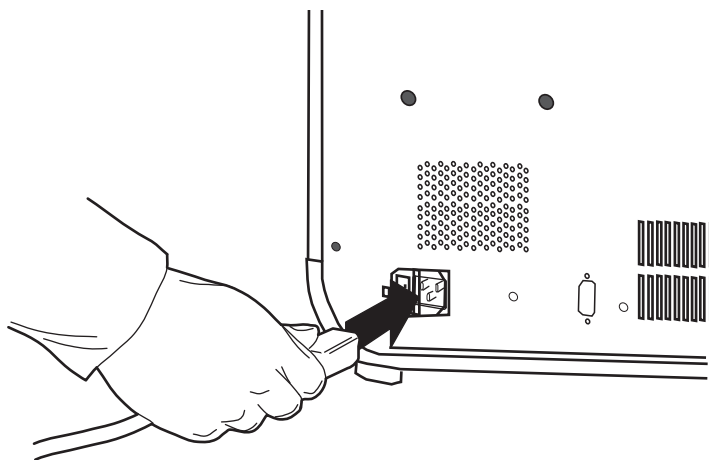

4. The ThinPrep 2000 Processor is designed with an automatic line voltage detection feature. This feature eliminates the need to manually change the system line voltage setting to meet your specific requirements. The instrument will automatically adapt to any line voltage between 100–120 VAC and 220–240 VAC.

Caution: Do not attach a cable to the 9-pin connector on the rear of the instrument. This connector is available for diagnostic purposes only.

Caution: The ThinPrep 2000 Processor is fused internally. No user accessible fuse is available.

SECTION
H

TURNING ON YOUR THINPREP 2000 PROCESSOR

1. Confirm that the internal securements have been removed from the instrument before proceeding with this procedure. Refer to “INTERNAL PACKAGING REMOVAL” on page 2.2, for more information.
2. With the door to the ThinPrep 2000 Processor closed, turn the toggle power switch, located on the right rear of the instrument, to the “1” (ON) position. For “On,” the top half of the toggle power switch is in the “in” position.
3. As the power is applied to the instrument, the control panel will display the following sequence of messages. If a different message appears in the display, follow the instructions on the control panel display or refer to Chapter 6, “Instrument Troubleshooting”, of this manual.

This message will appear for approximately four seconds:

```
CYTYC ThinPrep
Version V#.##
Computed CRC: ####
Firmware CRC: ####
```

At this point the system initializes all mechanisms while displaying this message for approximately four seconds:

```
CYTYC ThinPrep

Initializing System
Press STOP to Cancel
```



THINPREP 2000 INSTALLATION

After initialization, the system calibrates all pressure sensors while displaying this message for approximately twenty seconds:

```
Pressure Sensor  
calibration in  
progress.  
Please wait.
```

If the system initialization and calibration were successful, the control panel display will read:

```
Main Menu: Select  
1-SUPER          4-GYN  
2-FLU/FNA  
3-MUCOID        ↓- MORE
```

The above message indicates that the system is in idle mode.

4. Leave the power to the ThinPrep Processor on all the time. It is not necessary to turn it off unless instructed to do so for troubleshooting or maintenance procedures.
5. The ThinPrep Processor pressure sensor calibration occurs several times while the power is on:
 - at power up
 - 15 minutes after power up
 - 2 hours after power up
 - every 8 hours thereafter

SECTION

**RUN A BLANK SAMPLE**

When operating the ThinPrep 2000 Processor for the first time, it is important to run a sequence using a blank PreservCyt Solution vial (no cells) to ensure that the system is fully functional. Read Chapter 5A, “Operating Instructions”, of this manual before proceeding with the procedure below.

1. Load a PreservCyt Solution vial (no cells) into the processor.
2. Attach a ThinPrep Pap Test Filter to the filter cap and load this assembly into the processor.
3. Load a ThinPrep Slide into the processor.
4. Load an empty fixative vial into the processor.
5. Close the door.
6. Press key 4 to start the GYN sequence.
7. The instrument will now process the blank PreservCyt Solution vial.
8. Upon successful completion of the sequence, the slide will be in the fixative vial and the display will read:

```
COMPLETE: NOTE
```

```
Sample is dilute
```

```
Please press ENTER
```

If any other message is displayed, record the message and refer to Chapter 6, “Instrument Troubleshooting”, of this manual.

9. Press the ENTER key and following message appears:

```
COMPLETE
```

```
Remove Filter
```

```
Remove Fix Bath
```

10. Open the door.
11. Remove the filter cap and ThinPrep Pap Test Filter.
12. Remove the fixative vial containing the slide.
13. Remove the PreservCyt Solution vial.
14. The installation of the instrument is complete. The ThinPrep 2000 Processor is now ready for slide preparations. Read Chapter 7, “Maintenance”, of this manual before proceeding with additional slide preparations.



THINPREP 2000 INSTALLATION

SECTION J

STORAGE AND HANDLING - POST INSTALLATION

During operation the ThinPrep 2000 Processor is sensitive to vibrations. It should be placed on a sturdy bench away from centrifuges, vortexors or any other equipment that may cause vibrations.

Warning: The fixative vial must be removed. Evaporating alcohol could create a fire hazard.

SECTION K

TURNING OFF THE THINPREP 2000 PROCESSOR

Turning the Instrument Off

If the instrument is to be turned off, unload any items in it (refer to page 5A.18.)

Press the power switch to the off position (“O” position).

Taking the Instrument Out of Service (Extended Shutdown)

If the instrument is to be shut down for an extended time, follow the instructions for turning off the Processor.

Completely remove power to the instrument by unplugging the power cord from the wall outlet.

Chapter Three

PreservCyt Solution

SECTION
A

INTRODUCTION

The following sections describe the function and specifications of the cytologic preservative fluid, PreservCyt® Solution.

3 PRESERVCYT SOLUTION

SECTION B

PRESERVCYT® SOLUTION

PreservCyt Solution is a methanol-based, buffered solution designed to preserve cells during transport and slide preparation on the ThinPrep 2000 Processor.

The ThinPrep Processor slide preparation process also requires PreservCyt Solution for transporting and storing samples prior to processing. PreservCyt Solution is optimized for the ThinPrep Processor slide preparation process and cannot be substituted with any other reagents.

Packaging

Please refer to the **Ordering Information** of this manual for part numbers and detailed information regarding the ordering of solutions and supplies for the ThinPrep 2000 System.

- Vials(20 ml) of PreservCyt Solution are contained in each ThinPrep Pap Test.

Composition

PreservCyt Solution contains buffered methanol. It contains no reactive ingredients. It contains no active ingredients.

WARNING: Danger. PreservCyt Solution contains methanol. Toxic if swallowed. Toxic if inhaled. Causes damage to organs. Cannot be made non-poisonous. Keep away from heat, sparks, open flames and hot surfaces. Other solutions cannot be substituted for PreservCyt Solution.

Storage Requirements

- Store PreservCyt Solution between 15°C (59° F) and 30°C (86°F). Do not use beyond the expiration date printed on the container.
- Store PreservCyt Solution *with* cytologic sample intended for ThinPrep Pap testing between 15° C (59° F) and 30°C (86°F) for up to 6 weeks.
- Store PreservCyt Solution *with* cytologic sample intended for CT/NG testing using the Roche Diagnostics COBAS AMPLICOR CT/NG test between 4°C (39° F) and 25°C (77°F) for up to 6 weeks.
- Storage requirements for quantities of PreservCyt Solution are dependent on local regulations regarding the size and configuration of your facility. Please refer to the Solutions Storage Guide at the end of this chapter.

Transportation

When transporting a PreservCyt Solution vial containing cells, make sure the vial is tightly sealed. Align the mark on the cap with the mark on the vial to prevent leakage as shown in Figure 3-1. If the cap on the vial does not have a line, ensure the cap is tightened securely.

Figure 3-1 Aligning the vial cap

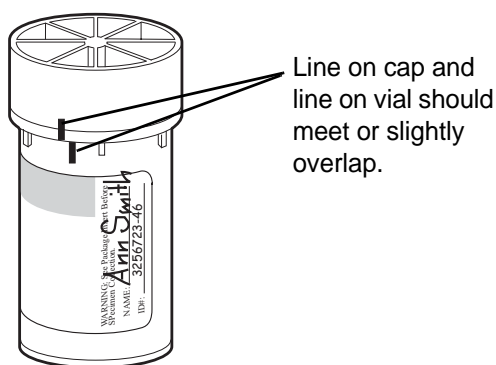

The shipping category for PreservCyt Solution is:

“flammable liquids, n.o.s. (methanol)” (USA only)

“flammable liquids, toxic, n.o.s. (methanol) (outside the USA)

The shipping category for PreservCyt Solution containing cells is “diagnostic sample.”

Please refer to the Shipping Requirements and Recommendations guide at the end of this chapter.

Stability

Do not use PreservCyt Solution after the expiration date on the container label. If making multiple slides from the same sample vial, be sure to make the slides before the expiration date marked on the sample vial. Expired vials should be discarded using appropriate laboratory procedures. Also, refer to storage requirements (page 3.2) for cell preservation limits.

Handling/Disposal

Handle all chemical-containing materials carefully in accordance with safe laboratory practices. When required by reagent composition, additional precautions are marked on the reagent containers or in the instructions for use.

Dispose of PreservCyt Solution according to the guidelines for disposing of hazardous waste. PreservCyt Solution contains methanol.

PreservCyt Solution was challenged with a variety of microbial and viral organisms. The following table presents the starting concentrations of viable organisms and the number of viable organisms found after 15 minutes in the PreservCyt Solution. The log reduction of viable organisms is also presented. As with all laboratory procedures, universal precautions should be followed.

Organism	Initial Concentration	Log Reduction after 15 min.
Candida albicans	5.5 x 10 ⁵ CFU/mL	>4.7
Aspergillus niger*	4.8 x 10 ⁵ CFU/mL	2.7
Escherichia coli	2.8 x 10 ⁵ CFU/mL	>4.4
Staphylococcus aureus	2.3 x 10 ⁵ CFU/mL	>4.4
Pseudomonas aeruginosa	2.5 x 10 ⁵ CFU/mL	>4.4
Mycobacterium tuberculosis**	9.4 x 10 ⁵ CFU/mL	4.9
Rabbitpox virus	6.0 x 10 ⁶ PFU/mL	5.5***
HIV-1	1.0 x 10 ^{7.5} TCID ₅₀ /mL	7.0***

* After 1 hour >4.7 log reduction

** After 1 hour >5.7 log reduction

*** Data is for 5 minutes

Interfering Substances

The use of lubricants (e.g., KY Jelly) should be avoided prior to specimen collection. Lubricants can adhere to the filter membrane and may cause poor cell transfer to the slide. If its use is unavoidable, the lubricant should be used in minimum amounts.

The National Fire Protection Association (NFPA) is the expert authority that local fire departments and fire safety code enforcement authorities look to for fire safety standards and codes. Their codes are developed through a consensus standards development process approved by the American National Standards Institute. The NFPA codes are used as guidelines by most fire code enforcement agencies. Since these codes are guidelines, your local Authority Having Jurisdiction (AHJ) for fire code enforcement may make the final determination. The summary chart below is based upon guidelines for facilities protected by standard sprinkler systems. ⁽³⁾

The ThinPrep products NFPA ratings are listed in a table below this chart.

Use this chart to help you determine your maximum storage limits for flammable and combustible liquids.

Maximum Quantities of Flammable and Combustible Liquids in Laboratory Units Outside of Inside Liquid Storage Areas⁽⁴⁾														
Lab Unit Fire Hazard Class	Flammable & Combustible Liquid Class	NFPA Code	Quantities in Use						Quantities in Use and Storage					
			Max per 100ft² (9.2m²) of Lab Unit⁽⁵⁾			Max Quantity per Lab Unit			Max per 100ft² (9.2m²) of Lab Unit⁽⁵⁾			Max Quantity per Lab Unit		
			Gallons	Liters	Vials⁽⁸⁾	Gallons	Liters	Vials⁽⁸⁾	Gallons	Liters	Vials⁽⁸⁾	Gallons	Liters	Vials⁽⁸⁾
A (High)	I	45-2015	10	38	1900	480	1820	91,000	20	76	3800	480	1820	91,000
	I, II, IIIA	45-2015	20	76	3800	800	3028	151,400	40	150	7500	1600	6060	303,000
B⁽⁶⁾ (Moderate)	I	45-2015	5	19	950	300	1136	56,800	10	38	1900	480	1820	91,000
	I, II, IIIA	45-2015	10	38	1900	400	1515	75,750	20	76	3800	800	3028	151,400
C⁽⁷⁾ (Low)	I	45-2015	2	7.5	375	150	570	28,500	4	15	750	300	1136	56,800
	I, II, IIIA	45-2015	4	15	750	200	757	37,8520	8	30	1500	400	1515	75,750
D⁽⁷⁾ (Minimal)	I	45-2015	1	4	200	75	284	14,200	2	7.5	375	150	570	28,500
	I, II, IIIA	45-2015	1	4	200	75	284	14,200	2	7.5	375	150	570	28,500

Maximum Quantities of PreservCyt Solution (Class IC) That Can Be Stored per Fire Area⁽⁹⁾ Outside a Safety Flammable Cabinet

Location	NFPA Code	Gallons	Liters	Vials⁽⁸⁾
General Warehouse ⁽¹⁰⁾⁽¹²⁾⁽¹³⁾	30-2015	120	460	23,000
Liquid Warehouse ^(3,11)	30-2015	Unlimited	Unlimited	Unlimited
Office, to include Exam Rooms	30-2015	10	38	1900

Allowable Quantities of PreservCyt Solution That Can Be Stored in a Liquid Storage Room

Location	NFPA Code	Gallons	Liters	Vials⁽⁸⁾
Maximum allowable storage per ft ² in an inside storage room that is smaller than 150ft ² in size.	30-2015	5	19	950
Maximum allowable storage per ft ² in an inside storage room that is larger than 150ft ² and less than 500ft ² in size.	30-2015	10	38	1900

- (1) Solution classifications: PreservCyt – Class IC; CytoLyt – Class II; CellFyx – Class IB
- (2) This information is Hologic’s summary of the various regulations. To view the codes in their entirety, please refer to NFPA 30 and NFPA 45.
- (3) A Liquid Warehouse shall have a sprinkler system that complies with the appropriate system indicated in NFPA 30.
- (4) An Inside Liquid Storage Area is a storage room totally enclosed within a building and having no exterior walls.
- (5) A Laboratory Unit is the area surrounded by firewalls per NFPA 30 *Flammable and Combustible Liquids Code*.
- (6) Reduce quantities by 50% for B laboratory units located above the 3rd floor.
- (7) Reduce quantities by 25% for C and D laboratory units located on the 4th-6th floors of a building and reduce quantities by 50% for C and D laboratory units above the 6th floor
- (8) 20ml PreservCyt vials.
- (9) A Fire Area is the area of a building separated from the remainder of the building by construction having a fire resistance of at least 1-hour and having all communicating openings properly protected by an assembly having a fire resistance rating of at least 1-hour per NFPA 30 *Flammable and Combustible Liquids Code*.

- (10) Allowable quantities in a warehouse can be increased with a sprinkler system rated higher than standard systems.
- (11) A Liquid Warehouse is a separate, detached building or attached building used for warehousing-type operations for liquids.
- (12) Quantities are permitted to be increased 100% where stored in approved flammable liquids storage cabinets.
- (13) Quantities are permitted to be increased 100% in buildings equipped throughout with an automatic sprinkler system installed in accordance with NFPA13, Standard for the Installation of Sprinkler Systems.

This table lists the NFPA ratings for all the ThinPrep products.

ThinPrep Product	Health Hazard	Flammability Hazard	Instability Hazard	Specific Hazard
ThinPrep PreservCyt Solution	2	3	0	N/A
ThinPrep CytoLyt Solution	2	2	0	N/A
ThinPrep CellFyx Solution	2	3	0	N/A
ThinPrep Rinse Solution	0	0	0	N/A
ThinPrep Bluing Solution	0	0	0	N/A
ThinPrep Rinse II Solution	2	3	0	N/A
ThinPrep Bluing II Solution	0	0	0	N/A
ThinPrep Stain EA Solution	2	3	0	N/A
ThinPrep Stain Orange G Solution	2	3	0	N/A
ThinPrep Nuclear Stain	2	0	0	N/A

ThinPrep® Solutions Shipping Requirements *

Scope:

These requirements include shipping:

- Biological specimens (patient specimens) in ThinPrep® solutions
- Biological specimens in solutions other than ThinPrep® solutions
- Biological specimens not in solutions
- ThinPrep® PreservCyt™ Solution without biological specimens
- ThinPrep® CytoLyt™ Solution without biological specimens

Note: Shippers of Hazardous Materials or Dangerous Goods must be trained according to the various Hazardous Materials/Dangerous Good regulations

A. Shipping Requirements when shipping patient samples in ThinPrep PreservCyt Solution only – Ambient Temperature:

1. Patient samples / biological substances (pathogens) contained ThinPrep PreservCyt Solution are neutralized or inactivated by the solution and as such no longer pose a health risk. (For further information regarding this, refer to the ThinPrep 2000 or ThinPrep 5000 Operators' Manual).
2. Materials that have been neutralized or inactivated are exempt from the Category B Class 6, Division 6.2 requirements.
3. Solutions that contain neutralized or inactivated pathogens, and meet the criteria of one or more of the other hazards risks, must be shipped according to the shipping requirements for that hazard risk(s).
4. ThinPrep PreservCyt Solution is a Flammable liquid when shipped domestic or international. Therefore, follow the instructions in Section C below, Shipping ThinPrep® PreservCyt™ Solution Only (such as from a laboratory to a physician).

B Shipping Biological Specimens in Solutions (other than ThinPrep PreservCyt Solution) or Without Solutions

Notes:

When biological specimens are shipped in a solution of a quantity of 30 ml or less and are packed in accordance with these guidelines, no further requirements in the Hazardous Materials (Dangerous Goods) Regulations need be met. However, training is recommended.”¹

Definitions:

- Biological Substance, Category B: Materials containing or suspected to contain infectious substances that do not meet Category A criteria. IATA Dangerous Goods regulations were revised with an effective date of January 1, 2015. Note: The term “diagnostic specimen” has been replaced with “biological substance, Category B”
- Exempt specimens: Specimens that with the minimal likelihood that pathogens are present (fixed tissue, etc.)

* These instructions are Hologic's interpretation of the various regulations as of the effective date. However, Hologic will not be responsible for any non-conformance to the actual regulations.

Shipping Requirements Category B or Exempt¹ – Ambient Temperature:

1. Packaging must consist of three components
 - a. a primary receptacle, leak proof
 - b. secondary packaging, leak proof
 - c. a rigid outer packaging

NOTES:

- FedEx will not accept clinical samples or diagnostic specimens packaged in FedEx envelopes, FedEx tubes, FedEx Paks, or FedEx Boxes, Styrofoam boxes, plastic bags, or paper envelopes.
- FedEx will accept clinical samples in FedEx Clinical Paks, FedEx Medium Clinical Boxes or FedEx Large Clinical Boxes.²

2. The primary receptacle cannot contain more than 1L of a liquid substance (500 ml if using FedEx).
3. If multiple fragile primary receptacles are placed in a single secondary packaging, they must be either individually wrapped or separated to prevent contact between them.
4. Absorbent material must be placed between the primary receptacle and the secondary packaging. The absorbent material (cotton balls, cellulose wadding, absorbent packets, paper towels) must be in sufficient quantity to absorb the entire contents of the primary receptacle(s) so that any release of the liquid substance will not compromise the integrity of the cushioning material or the outer packaging.
5. The outer packaging must not contain more than 4L or 4kg of material. This quantity excludes ice, dry ice, or liquid nitrogen when used to keep specimens cold.
6. An itemized list of contents must be enclosed between the secondary packaging and the outer packaging.
7. The packaging must successfully pass a 4 ft. drop test (Section 6.6.1 IATA regulations).
8. The UN3373 mark must be displayed on the external surface of the outer packaging (one surface of the outer packaging must have a minimum dimension of 100 mm x 100 mm FedEx minimum is 7"x 4"x 2") on a background of a contrasting color and must be clearly visible and legible. The mark must be in the form of a diamond with each side having a length of at least 50 mm. Lettering must be at least 6mm high.
9. The proper shipping name "Biological Substance, Category B" in letters at least 6mm high must be marked on the outer package adjacent to the diamond shaped UN3373 mark.

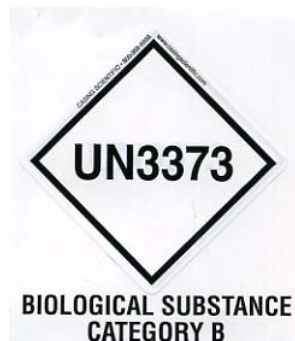

10. If using FedEx, the FedEx USA Airbill, Section 6, Special Handling must be completed with dangerous goods/dry ice information:

Does this shipment contain dangerous goods?

YES- Shipper's Declaration not required

11. The outer container of all diagnostic/clinical specimen packages must display the following:

- a. Sender's name and address
- b. Recipient's name and address
- c. The words "Biological Substance, Category B"
- d. The UN 3373 label

Shipping Requirements Category B or Exempt¹ – Frozen or Refrigerated Specimens:

NOTE: FedEx defers to IATA regulations for the shipping of refrigerated or frozen diagnostic specimens.²

Follow all packaging directions for Category B or Exempt – Ambient Temperature plus:

1. Place ice or dry ice outside of the secondary packaging. Interior supports must be provided to secure the secondary packaging in the original position after the ice or dry ice has dissipated. If ice is used, the outside packaging or overpack must be leak proof. If dry ice is used, the packaging must be designed and constructed to permit the release of CO² gas to prevent a buildup of pressure that could rupture the packaging.

2. Always affix the Class 9, UN 1845 dry ice label as well as the UN 3373, Biological Substance, Category B label to these shipments

3. If using FedEx, the FedEx USA Airbill, Section 6, Special Handling must be completed with dangerous goods/dry ice information:

Does this shipment contain dangerous goods?

YES- Shipper's Declaration not required

Enter kg of dry ice used (if applicable)

4. The outer container of all diagnostic/clinical specimen packages must display the following:

- a. Sender's name and address
- b. Recipient's name and address
- c. The words "Biological Substance, Category B"
- d. The UN 3373 label
- e. Class 9 label, including UN 1845, and net weight if packaged with dry ice

C Shipping ThinPrep[®] PreservCyt[™] Solution Only (such as from a laboratory to a physician)

Domestic Ground Shipments - Limited Quantities:

Notes:

ThinPrep® PreservCyt™ Solution is classified as a Class 3 Flammable liquid, assigned to Packing Group III (PG III).

49 CFR 173.150 (Limited Quantities) allows ThinPrep® PreservCyt™ Solution in vials to be shipped in Limited Quantities when shipped via ground transportation in a sturdy box. The total volume in a package cannot exceed 5 liters or weigh more than 30 kg (66 lbs). Limited Quantities are exempt from labeling requirements.

Limited Quantity domestic ground shipping recommendations:

1. ThinPrep® PreservCyt™ Solution must be shipped in the vials.
2. Place the vials in a good quality cardboard box, such as the ThinPrep® box that holds 250 vials. Pack vials in a manner (adding protective packing material as necessary) as to limit movement of individual vials.
3. Mark the package as “Flammable liquids, n.o.s., (Methanol Solution), 3, UN1993, Ltd. Qty.” add orientation arrows on the ends, and the Limited Quantity label:

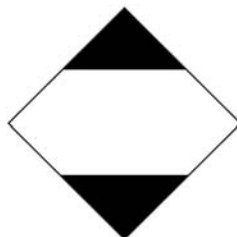

4. Print “UN1993, Flammable liquids, n.o.s., (Methanol Solution), 3, PG III, Ltd. Qty.” on the Shipping papers.

Domestic Ground Shipments - Other than Limited Quantities:

When shipping packages in excess of “Limited Quantity” amounts:

1. Do not include “Ltd Qty” in the wording on the package or on the Shipping papers as indicated in c and d above.
2. Affix a Class 3 “Flammable Liquid” hazard label to the outer package in close proximity of the wording described in “C” above. See the example of the label on the last page of these recommendations.
3. Mark the package as “Flammable liquids, n.o.s., (Methanol Solution), 3, UN1993, Net Qty.”

Domestic Air Shipments:

In addition to 1 and 2 above in Domestic Ground Shipments – Other than Limited Quantities, the following are recommendations for domestic air shipments:

3. Maximum allowable package sizes are:
 - i. Sixty (60) liters (3000-vials) for passenger aircraft, and
 - ii. Two hundred twenty (220) liters (11,000-vials) for cargo aircraft.

4. Single packages containing more than sixty (60) liters (3000-vials) of total product must be clearly marked "FOR CARGO AIRCRAFT ONLY".
5. The vials must be shipped in United Nations (UN) certified 4G packaging for any quantity in an aircraft. (e.g., ThinPrep® PreservCyt™ Solution 250-vial box or equivalent.)
6. A Class 3 "Flammable Liquid" label must be affixed to the outer package near the words "Flammable liquids, n.o.s., (Methanol Solution)".



All Domestic Shipments:

The following are recommendations for all domestic ground and air shipments:

1. If the ThinPrep® PreservCyt™ Solution is shipped in a package also containing non-hazardous material, the hazardous material must be listed first, or be printed in a contrasting color (or highlighted) to differentiate it from the non-hazardous material.
2. The total volume of ThinPrep® PreservCyt™ Solution and the number of vials must appear on the shipping papers.

International Ground Shipments - Limited Quantities:

When shipping internationally, ThinPrep® PreservCyt™ Solution is classified with a primary hazard of Class 3 (Flammable Liquid), and with a secondary hazard of Class 6.1 (Toxic). It is assigned to PG III.

The reference used for the international ground recommendations is the *ADR - European Agreement Concerning the International Carriage of Dangerous Good by Road* (United Nations). A "Limited Quantity" is defined as a package containing a maximum net quantity of 5-liters and not weighing more than 20 kg (40 lbs). The recommendations for international ground shipments are as follows:

1. ThinPrep® PreservCyt™ Solution must be shipped in the vials.
2. Place the vials in a good quality cardboard box, such as the Cytoc box that holds 250 vials. Pack vials in a manner (adding protective packing material as necessary) as to limit movement of individual vials.
3. Mark the package with "UN1992, Flammable liquids, toxic, n.o.s., (Methanol Solution), 3, 6.1, PGIII Ltd. Qty" orientation arrows on the ends and the Limited Quantity label that has a "Y" on it.



4. The shipping papers should include all the information indicated in "3" above.

International Ground Shipments – Other than Limited Quantities:

1. Do not include "Ltd Qty" in the wording on the package or on the Shipping papers as indicated in c and d above.
2. Affix both a Class 3 "Flammable Liquid" label and a secondary Class 6.1 "Toxic" label to the package adjacent to the markings. (Copies of the labels can be found on the last page of this document.)



Class 6.1 "Toxic" secondary hazard label.

3. Mark the package with "UN1992, Flammable liquids, toxic, n.o.s., (Methanol Solution), 3, 6.1, PG III, Net Qty".

International Air Shipments:

The references used for the International Air recommendations are: In addition to a and b above in International Ground Shipments, the following are the recommendations for international air shipments:

1. Maximum allowable package sizes are:
 - i. Sixty (60) liters (3000-vials) for passenger aircraft, and
 - ii. Two hundred twenty (220) liters (11,000-vials) for cargo aircraft.
2. Packages containing more than sixty (60) liters of product must be clearly marked "FOR CARGO AIRCRAFT ONLY"
3. The vials must be shipped in United Nations (UN) certified 4G packaging for any quantity in an aircraft. (e.g., ThinPrep® PreservCyt™ Solution 250-vial box or equivalent.) Pack vials in a manner (adding protective packing material as necessary) as to limit movement of individual vials.
4. Limited Quantity exemption can only be used if the package has a maximum net quantity of 2-liters.
5. Packaging manufacturer's specifications markings are not required when shipping Limited Quantity.
6. Mark the package with "UN1992, Flammable liquids, toxic, n.o.s., (Methanol Solution), 3, 6.1, PGIII, Net. Qty".
7. When a "Cargo Aircraft Only" marking is required, it must be affixed on the same package surface and near the hazard labels.
8. The shipper is responsible for the completion of a "Shipper's Declaration for Dangerous Goods" form.

D. Shipping ThinPrep® CytoLyt™ Solution Only (such as from a laboratory to a physician)

Domestic Ground Shipments:

ThinPrep® CytoLyt™ Solution has a flash point of 109° F. For domestic ground transportation only, a flammable liquid with a flashpoint at or above 100° F that does not meet the definition of any other hazard class may be reclassified as a combustible liquid. As such, ThinPrep® CytoLyt™ Solution, shipped via ground, is exempt from the requirements of the DOT Hazardous Materials Regulations.

Domestic Air Shipments:

When shipping ThinPrep® CytoLyt™ Solution via air, follow the Domestic Air Shipments recommendations for Shipping ThinPrep® PreservCyt™ Solution Only that can be found in Section C of this document.

International Ground and Air shipments:

When shipping ThinPrep® CytoLyt™ Solution via ground or air, follow the International Ground or Air Shipments recommendations for Shipping ThinPrep® PreservCyt™ Solution Only guidelines that can be found in Section C of this document.

E. Shipping ThinPrep® CytoLyt™ Solution With Patient Sample (such as from a physician to a laboratory)

Domestic Shipments:

ThinPrep® CytoLyt™ Solution containing a patient sample is classified as a Biological Substance, Category B. Follow the recommendations in Section B of this document.

International Shipments:

ThinPrep® CytoLyt™ Solution containing a patient sample is classified as a Biological Substance, Category B. Follow the recommendations in Section B of this document.

References:

- 49 CFR 100 to 185, *Transportation*
- *Dangerous Goods Regulations*, 56th Edition, 2015, International Air Transportation Association (IATA)
- International Civil Aviation Organization's (ICAO) *Technical Instructions for the Safe Transport of Dangerous Goods by Air*

Foot Notes:

1. See Packing Instruction 650 in the IATA *Dangerous Goods Regulations*
2. FedEx Document 33539PL: "Packaging Clinical Samples" and "Packaging UN 3373 Shipments"

**4. Gynecologic
Sample Preparation**

**4. Gynecologic
Sample Preparation**

Chapter Four

Gynecologic Sample Preparation

SECTION
A

INTRODUCTION

Includes cell samples from the ectocervix and the endocervix.

	<p>1. Collection: Deposit the specimen directly into a PreservCyt[®] Solution Vial.</p>
	<p>2. Allow to Stand in PreservCyt Solution for 15 Minutes</p>
	<p>3. Run on ThinPrep[®] 2000 Processor using Sequence 4, Fix, Stain, and Evaluate</p>



GYNECOLOGIC SAMPLE PREPARATION

SECTION B

COLLECTION PREPARATION

ThinPrep Collection Techniques

The detection of cervical cancer and its precursors as well as other gynecologic abnormalities is the primary purpose of obtaining a cervical cell sample. The following guidelines are referenced from Clinical and Laboratory Standard Institute Guidelines, (CLSI, formerly NCCLS) Document GP15-A3¹ and are recommended in the collection process for obtaining a ThinPrep Pap Test (TPPT) specimen. In general, the guidelines state that it is important to obtain a specimen that is not obscured by blood, mucus, inflammatory exudate or lubricant.

Patient Information

- The patient should be tested 2 weeks after the first day of her last menstrual period, and definitely not when she is menstruating.

Even though the TPPT reduces obscuring blood, clinical studies have demonstrated that excessive amounts of blood may still compromise the test and possibly lead to an unsatisfactory result.²

- The patient should not use vaginal medication, vaginal contraceptives, or douches during the 48 hours before the exam.

Specimen Collection Preparation

- Lubricant jellies should not be used to lubricate the speculum.

Even though lubricant jellies are water soluble, excessive amounts of jelly may compromise the test and possibly lead to an unsatisfactory result.

- Remove excess mucus or other discharge present before taking the sample. This should be gently removed with ring forceps holding a folded gauze pad.

The excess cervical mucus is essentially devoid of meaningful cellular material and when present in the sample vial may yield a slide with little or no diagnostic material present.

- Remove inflammatory exudate from the cervical canal before taking the sample. Remove by placing a dry 2 x 2 inch (5 x 5 cm) piece of gauze over the cervix and peeling it away after it absorbs the exudate or by using a dry proctoswab or scopette.

The excess inflammatory exudate is essentially devoid of diagnostic cellular material and when present in the sample vial may yield a slide with little or no diagnostic material present.

- The cervix should not be cleaned by washing with saline or it may result in a relatively acellular specimen.
- The sample should be obtained before the application of acetic acid.

1. Papanicolaou Technique Approved Guidelines (CLSI Document GP15-A3, third edition, 2008)

2. Lee et al. Comparison of Conventional Papanicolaou Smears and Fluid-Based, Thin-Layer System for Cervical Cancer Screening. *Ob Gyn* 1997; 90: 278-284.

SECTION
C

SPECIMEN COLLECTION

Collect Gynecologic Sample Using the Broom-Like Device

Physician/clinician instructions for collecting gynecologic samples.

	<p>1. Obtain an adequate sampling from the cervix using a broom-like device. Insert the central bristles of the broom into the endocervical canal deep enough to allow the shorter bristles to fully contact the ectocervix. Push gently, and rotate the broom in a clockwise direction five times.</p>
	<p>2. Rinse the broom as quickly as possible into the PreservCyt Solution vial by pushing the broom into the bottom of the vial 10 times, forcing the bristles apart. As a final step, swirl the broom vigorously to further release material. Discard the collection device.</p>
	<p>3. Tighten the cap so that the torque line on the cap passes the torque line on the vial.</p>
	<p>4. Record the patient's name and ID number on the vial. Record the patient information and medical history on the cytology request form.</p>
	<p>Note: If the sample is to be processed immediately, allow the sample to stand in the PreservCyt Solution Vial for at least 15 minutes before processing. If the sample is to be sent elsewhere for processing, continue with the next step.</p>
	<p>5. Place the vial and requisition in a specimen bag for transport to the laboratory.</p>









Refer to the instructions provided with the collection device for warnings, contraindications, and limitations associated with specimen collection.

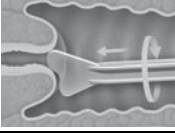

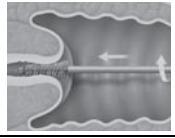
GYNECOLOGIC SAMPLE PREPARATION

Collect Gynecologic Sample, Using the Endocervical Brush/Spatula Device

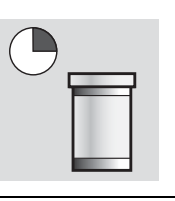
Physician/clinician instructions for collecting gynecologic samples.

	<p>1. Obtain an adequate sampling from the ectocervix using a <i>plastic</i> spatula.</p>
	<p>2. Rinse the spatula as quickly as possible into the PreservCyt Solution vial by swirling the spatula vigorously in the vial 10 times. Discard the spatula.</p>
	<p>3. Obtain an adequate sampling from the endocervix using an endocervical brush device. Insert brush into the cervix until only the bottom-most fibers are exposed. Slowly rotate 1/4 or 1/2 turn in one direction. DO NOT OVER-ROTATE.</p>
	<p>4. Rinse the brush as quickly as possible in the PreservCyt Solution by rotating the device in the solution 10 times while pushing against the PreservCyt vial wall. Swirl vigorously to further release material. Discard the brush.</p>
	<p>5. Tighten the cap so that the torque line on the cap passes the torque line on the vial.</p>
	<p>6. Record the patient's name and ID number on the vial. Record the patient information and medical history on the cytology requisition form.</p>
	<p>Note: If the sample is to be processed immediately, allow the sample to stand in the PreservCyt Solution Vial for at least 15 minutes before processing. If the sample is to be sent elsewhere for processing, continue with the next step.</p>
	<p>7. Place the vial and requisition in a specimen bag for transport to the laboratory.</p>

Refer to the instructions provided with the collection device for warnings, contraindications, and limitations associated with specimen collection.

SECTION
D

SPECIAL PRECAUTIONS

PreservCyt Solution

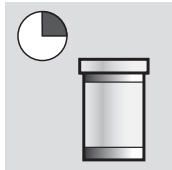
	After sample transfer to the PreservCyt Solution Vial, the sample should stand for at least 15 minutes before processing.
---	---

For more information on PreservCyt Solution, refer to Chapter 3, “PreservCyt Solution”.

Interfering Substances

The Clinical and Laboratory Standard Institute Guidelines (formerly NCCLS) recommend that no lubricant be used during pap testing.¹

ACOG recommends that care be taken not to contaminate the specimen with lubricant because this may lead to unsatisfactory results.² This applies to both conventional pap testing and liquid based cytology.

If you are using a plastic speculum, or in instances where a lubricant must be used, take care not to contaminate the cervix or collection devices with the lubricant. A tiny amount of lubricant may be used, just enough to sparingly coat the speculum with a gloved finger, avoiding the tip of the speculum.

The Clinical and Laboratory Standard Institute Guidelines and ACOG recommend that you not take a Pap during menses.¹⁻²

For samples to be processed on the ThinPrep 2000 Processor, lubricants can adhere to the filter membrane and may cause poor cell transfer to the slide. If its use is unavoidable, the lubricant should be used in minimum amounts.

1. Papanicolaou Technique Approved Guidelines (CLSI Document GP15-A3, third edition, 2008)

2. ACOG Practice Bulletin, no. 45, August 2003

4

GYNECOLOGIC SAMPLE PREPARATION

Handling/Disposal

Handle all chemical-containing materials carefully in accordance with safe laboratory practices. When required by reagent composition, additional precautions are marked on the reagent containers.

Dispose of PreservCyt Solution according to your guidelines for disposing of hazardous waste. PreservCyt Solution contains methanol.

SECTION E

SPECIMEN PROCESSING

Materials Required

Refer to Materials Required sections on page 1.5 and page 5A.4 for a list and explanation of materials provided and materials required but not provided.

Specimen Preparation

- The gynecologic sample should be deposited in the PreservCyt Solution immediately upon collection.
- The PreservCyt Sample vial fluid level should be within the frosted area of the sample vial.

Figure 4-1 PreservCyt Sample Vial Fluid Level

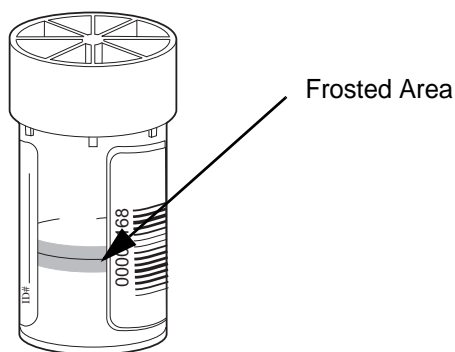

- Store PreservCyt Solution *with* cytologic sample intended for ThinPrep Pap testing between 15° C (59° F) and 30°C (86°F) for up to 6 weeks.

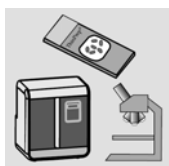
Run On ThinPrep 2000 Processor Using Sequence 4, Fix, Stain, And Evaluate

The operator loads the instrument and selects sequence number 4 for the sample to be processed as described in Chapter 5A, “Operating Instructions”. At the completion of the process, the operator fixes and stains the slide according to the procedure in Chapter 8, “Fixation, Staining, and Coverslipping”.

Stability

Store PreservCyt Solution *with* cytologic sample intended for ThinPrep Pap testing between 15° C (59° F) and 30° C (86° F) for up to 6 weeks.

SECTION

F

SAMPLE PROCESSING TROUBLESHOOTING**REPROCESSING A THINPREP PAP TEST SAMPLE VIAL FOLLOWING AN UNSATISFACTORY RESULT**

Laboratory personnel may reprocess ThinPrep Pap Test specimens where slides have been interpreted as inadequate (“Unsatisfactory for Evaluation”) for diagnosis following Cytotechnologist screening. The instructions below must be followed in order to properly reprocess these specimens:



Note: Reprocessing a ThinPrep Pap Test specimen may only be performed once.

Note: Good laboratory practices should be followed to avoid introducing contaminants into the PreservCyt Solution sample vial.

4

GYNECOLOGIC SAMPLE PREPARATION

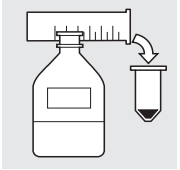
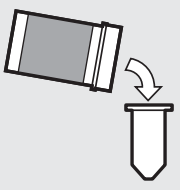
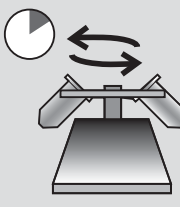
Reprocessing Protocol

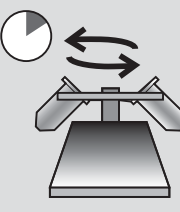
	<p>1 Prepare a wash solution of sufficient volume to add 30 mL to every ThinPrep Pap Test specimen being reprocessed. The wash solution is made by mixing 9 parts CytoLyt Solution with 1 part glacial acetic acid.</p>
	<p>2 Prior to performing this step, assure there is sufficient volume in the ThinPrep Pap Test specimen to result in a pellet, following centrifugation. Pour the contents of the ThinPrep Pap Test specimen into a centrifuge tube appropriately labeled to maintain chain of custody. Retain the vial.</p>
	<p>3 Pellet the contents of the centrifuge tube by centrifugation at 1200 x g for 5 minutes.</p> <p>Note: Once centrifugation is complete, the cell pellet should be clearly visible but the cells may not be tightly packed together (the pellet may appear fluffy).</p>
	<p>4</p> <ol style="list-style-type: none"> Carefully pour off the supernatant from the centrifuge tube to avoid loss of cells. Dispose of according to local regulations. Vortex the centrifuge tube briefly. Pour 30 mL of the CytoLyt Solution and 10% glacial acetic acid mixture into the centrifuge tube and cap securely. Invert the centrifuge tube by hand several times to mix.
	<p>5 Pellet the cells again by centrifugation - 1200 x g for 5 minutes.</p>

	<p>6</p> <p>a. Carefully pour off the supernatant from the centrifuge tube to avoid loss of cells. Dispose of according to local regulations.</p> <p>b. Vortex the centrifuge tube briefly.</p>
	<p>7</p> <p>a. Using the volume markings on the centrifuge tube, pour the necessary quantity of unused (i.e., containing no patient specimens) PreservCyt Solution to the cells and fill to a final volume of 20 mL. Secure the cap tightly.</p> <p>b. Invert the centrifuge tube several times to mix and transfer the sample back into the retained specimen vial.</p>
	<p>8</p> <p>Process the specimen using a ThinPrep 2000 Processor according to the procedure for running gynecologic specimens. Evaluate the resultant slide according to <i>The Bethesda System for Reporting Cervical/Vaginal Cytologic Diagnosis</i>. If after reprocessing, negative results from specimen do not fit with the clinical impression, a new specimen may be necessary.</p>



GYNECOLOGIC SAMPLE PREPARATION

This page intentionally left blank.

**5. Operating
Instructions**

**5. Operating
Instructions**

Chapter Five A

Operating Instructions

Note: Specific processing steps must be followed before and during use of the ThinPrep® 2000 processor if planning to perform *Chlamydia trachomatis* and *Neisseria gonorrhoeae* testing, using the Roche Diagnostics COBAS AMPLICOR™ CT/NG Test, on the residual specimen after a slide has been prepared using the ThinPrep 2000 processor. Follow the procedures found in Chapter 5B of the ThinPrep 2000 Operator's Manual.

SECTION A

INTRODUCTION

This section provides instructions for operating the ThinPrep® 2000 Processor.

The following topics are covered in this section:

- SECTION B:** Optional Instructions for Ancillary Testing
- SECTION C:** Material Requirements
- SECTION D:** Pre-Operation Checklist
- SECTION E:** Overview of Loading the ThinPrep 2000 Processor
- SECTION F:** Loading the PreservCyt® Sample Vial
- SECTION G:** Loading the ThinPrep Pap Test Filter
- SECTION H:** Loading the ThinPrep Microscope Slide
- SECTION I:** Loading the Fixative Vial
- SECTION J:** Closing the Door
- SECTION K:** Selecting and Initiating a Sequence
- SECTION L:** Unloading the ThinPrep 2000 Processor
- SECTION M:** Interrupting the Slide Preparation Process
- SECTION N:** Status, Maintenance, and Test Screens

**SECTION
B****OPTIONAL INSTRUCTIONS FOR ANCILLARY TESTING**

Testing for certain sexually transmitted diseases (STD) and for Human Papilloma Virus (HPV) in conjunction with cytology may be performed using the residual specimen remaining in the PreservCyt sample vial after preparation of the ThinPrep Pap Test slide. Such testing may also be enabled by the removal of an aliquot of up to 4 ml (Aliquot Removal) from the PreservCyt sample vial before preparing the ThinPrep Pap Test slide.

Laboratory personnel must follow the specific instructions in this section to appropriately remove the desired aliquot volume and prepare the PreservCyt sample vial for the ThinPrep Pap Test. Adherence to these instructions must be maintained to ensure there is no adverse effect on the ThinPrep Pap Test result.

Because cytology/HPV testing and STD testing address different clinical questions, Aliquot Removal may not be suitable for all clinical situations. Physicians and other persons responsible for ordering clinical tests should be familiar with the following:

- There is no evidence of degradation of cytology results by Aliquot Removal, however, this cannot be ruled out for all specimens. As with any subsampling step in anatomic pathology, chance misallocation of diagnostic cells may occur if they are very rare. If negative results from the specimen do not fit with the clinical impression, a new specimen may be necessary.
- Aliquot Removal from low-cellularity specimens may leave insufficient material in the PreservCyt sample vial for preparation of a satisfactory ThinPrep Pap Test slide.
- Aliquot Removal may leave insufficient material in the PreservCyt sample vial for performance of ancillary testing (e.g., reflexive HPV testing) using the residual specimen following preparation of a ThinPrep Pap Test slide.
- Co-collection of separate samples for the ThinPrep Pap Test and STD testing may be considered in lieu of Aliquot Removal.
- When opting for concurrent cytologic and STD testing, providers should consider risk and clinical history (e.g., disease prevalence, patient age, sexual history or pregnancy) as well as specimen suitability (e.g., exudates or bleeding) that can impact diagnostic reliability.

Sexually Transmitted Diseases Treatment Guidelines 2002 (Centers for Disease Control and Prevention, MMWR 2002: 51(No. RR-6)) provides clinical guidance for the management and treatment of individual patients, including use of Pap testing.

It is essential that the instructions in Chapter 5B be followed if the Roche Diagnostics COBAS AMPLICOR™ CT/NG Test will be performed using the residual specimen after a slide has been prepared using the ThinPrep 2000 processor.

Removing an Aliquot (of up to 4 ml) from the PreservCyt Sample Vial prior to performing the ThinPrep Pap Test

Note: Only one aliquot may be removed from the PreservCyt sample vial prior to performing the ThinPrep Pap Test, regardless of the volume of the aliquot (maximum aliquot volume = 4 ml).

Note: Good laboratory practices should be followed to avoid introducing contaminants into either the PreservCyt sample vial or the aliquot. It is recommended to use powder-free gloves and an individually wrapped, disposable pipetting device with an aerosol barrier tip that is sized appropriately for the volume being withdrawn and dispensed. You should not use serological pipettes. In order to minimize the potential for cross contamination, aliquot removal should be performed in an appropriate location outside an area where amplification is performed.

1. Vortex the vial at high speed for 8 to 12 seconds.

Caution The desired aliquot must be removed immediately after vortexing the vial to ensure homogeneity of the sample.

2. Carefully remove the vial cap.
3. Using a pipetting device, withdraw an aliquot of up to 4 ml from the vial. Take care to avoid contaminating gloves with solution. If gloves should become contaminated, replace with a clean pair before proceeding to the next specimen.
4. Dispense the aliquot into a suitably sized and labeled polypropylene tube and close tightly to prevent leakage/evaporation.
5. Store the aliquot under conditions appropriate for ancillary test(s). Refer to manufacturer or laboratory instructions for performing ancillary test(s) on the aliquot.
6. Dispose of the pipetting device in accordance with local, state, and federal regulations.
7. Using a new pipetting device, withdraw a quantity of unused PreservCyt Solution from its container that is equal in volume to that of the aliquot removed from the vial in step 3.
8. Transfer the volume of unused PreservCyt Solution to the vial from which the aliquot was removed in step 3.
9. Secure the vial cap. (The line on the cap and line on the vial should meet or slightly overlap.)
10. Dispose of the pipetting device in accordance with local, state, and federal regulations.
11. Refer to the remaining steps in this chapter to complete the ThinPrep Pap Test.

SECTION
C

MATERIAL REQUIREMENTS

Figure 5A-1 The required materials

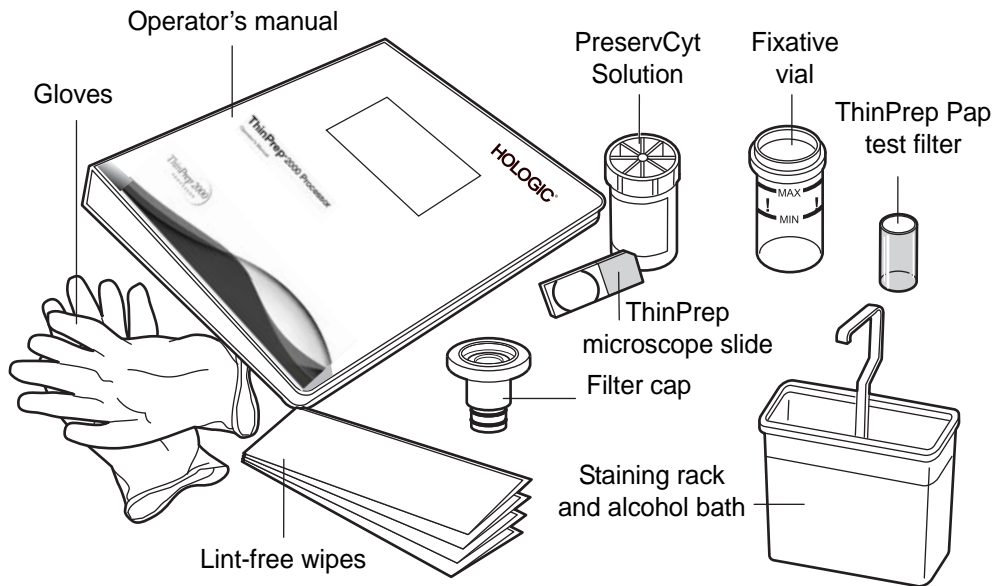

The **PreservCyt Solution** vial is a plastic vial that contains an alcohol-based preservative solution that preserves cells from all body sites for up to three weeks at room temperature. For more information on PreservCyt Solution, refer to Chapter 3, "PreservCyt Solution".

The **ThinPrep Pap Test Filter** is a disposable plastic cylinder that is open at one end and has a filter membrane bonded onto the other end. The filter membrane has a flat, smooth, porous surface.

The **filter cap** is a plastic cap that fits onto the open end of the ThinPrep Pap Test Filter and mounts the ThinPrep Pap Test Filter into the processor.

The **fixative vial** is a plastic vial that should be filled with standard laboratory fixative alcohol. After the ThinPrep Processor transfers cells onto the slide, it automatically ejects the slide into the fixative vial.

The **ThinPrep Microscope Slide** is a high-quality, pre-cleaned glass microscope slide with a defined screening area and a larger labeling area. The slide is specifically designed for use with the ThinPrep Processor.

Supplies used in the ThinPrep 2000 System are those designed and supplied by Hologic specifically for the ThinPrep 2000 Processor. These include PreservCyt Solution vials for use with the ThinPrep Pap Test, Gyn ThinPrep Pap Test Filters (clear), and ThinPrep Microscope Slides. For gynecologic use, these supplies are required for proper performance of the system and cannot be substituted with

any other items. Product performance will be compromised if other supplies are used. After use, supplies should be disposed of in accordance with local, state, and federal regulations.

The **ThinPrep 2000 System Operator's Manual** contains detailed information about the ThinPrep 2000 System, such as the principles of operation, operating instructions, specifications, and maintenance information. The manual also contains information on the solutions and materials required to prepare slides with the ThinPrep 2000 Processor.

Disposable laboratory gloves — non-powdered gloves are recommended.

Lint-free wipes.

Alcohol bath with slide staining rack and standard laboratory fixative alcohol.

SECTION

D

PRE-OPERATION CHECKLIST

The following conditions should be checked before preparing a slide on the ThinPrep 2000 Processor.

- Waste bottle — Make sure the fluid level of the waste bottle is below the "MAX" fill line of the bottle. Refer to "EMPTYING WASTE BOTTLE" on page 7.2, for emptying instructions.
- Idle mode — Confirm that the instrument is powered on and in idle, or Main Menu, mode. If the Main Menu is not displayed, follow the instructions on the display until the idle mode appears. If the system's power is off, refer to "TURNING ON YOUR THINPREP 2000 PROCESSOR" on page 2.9 for turning system power on.
- Filter seal O-rings — Make sure that the two O-rings at the base of the filter cap are not dry, cracked, or in need of lubrication. Refer to "FILTER CAP O-RING LUBRICATION" on page 7.5, for lubrication and/or replacement instructions.
- Disposable laboratory gloves — Always wear disposable laboratory gloves and other lab safety garments when operating the ThinPrep Processor.

Note: Once sample has been added to a PreservCyt *Solution* vial, the vial is then designated as a *PreservCyt sample vial*.

SECTION
E

OVERVIEW OF LOADING THE THINPREP® 2000 PROCESSOR

The next four sections describe in detail the methods for loading the ThinPrep 2000 Processor. The following supplies must be loaded into the processor before initiating a sample run:

- PreservCyt Sample vial
- ThinPrep Pap Test Filter
- ThinPrep Microscope Slide
- Fixative Vial

The figure below shows the ThinPrep 2000 Processor after loading of the supplies is complete.

Figure 5A-2 ThinPrep 2000 Processor loaded with supplies

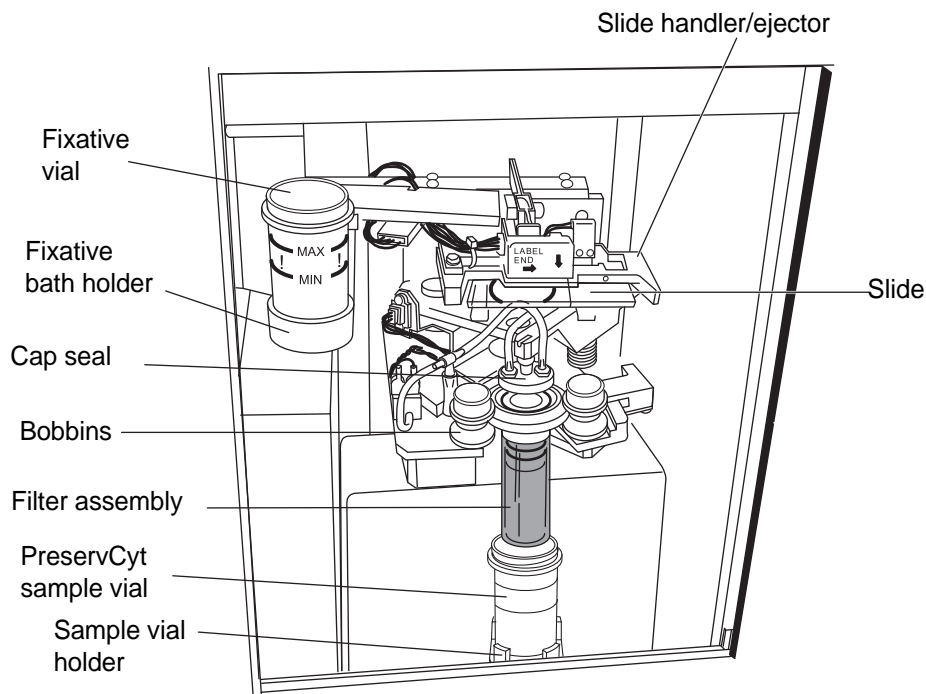

SECTION
F

LOADING THE PRESERVACYT SAMPLE VIAL

1. Completely open the ThinPrep 2000 Processor door.
2. Confirm that the sample holder, fixative vial holder, and slide handler are empty.
3. Remove the cap from the PreservCyt sample vial.
4. Gently place the PreservCyt sample vial into the sample holder until the bottom of the vial rests on the sample holder base. Refer to Figure 5A-3.
5. The vial will remain loose in the sample holder until the process begins. The instrument will automatically grasp the vial during processing.

Figure 5A-3 Loading the PreservCyt sample vial

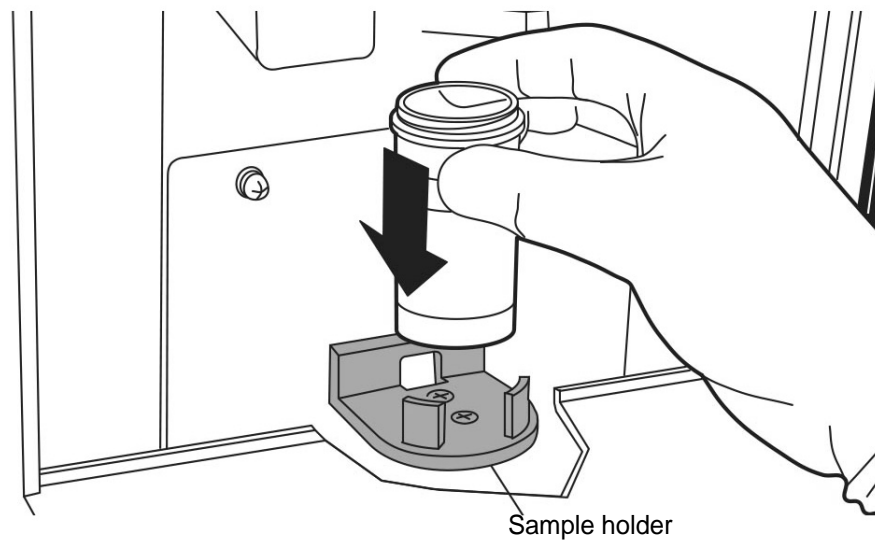

SECTION
G

LOADING THE THINPREP PAP TEST FILTER

1. Remove a new ThinPrep Pap Test Filter from the storage tray by grasping the sides of the cylinder.

Caution: Never touch the filter membrane of the ThinPrep Pap Test Filter.

2. There are two different techniques for mating the ThinPrep Pap Test Filter and filter cap. This configuration of the two parts is called a filter assembly.

Note: Handle the filter cap gently. Do not hit it against hard surfaces.

Method A:

Hold the filter cap in the palm of one hand and the ThinPrep Pap Test Filter in the other hand as shown in Figure 5A-4. Insert the ThinPrep Pap Test filter.

Method B:

Place the filter cap on the bench and hold the ThinPrep Pap Test Filter in one hand. Insert the ThinPrep Pap Test Filter.

Using a slight twisting motion with either method will prevent unwanted O-ring roll. The filter seal O-rings should be lightly greased. Refer to "FILTER CAP O-RING LUBRICATION" on page 7.5.

Figure 5A-4 Assembling the filter cap and filter

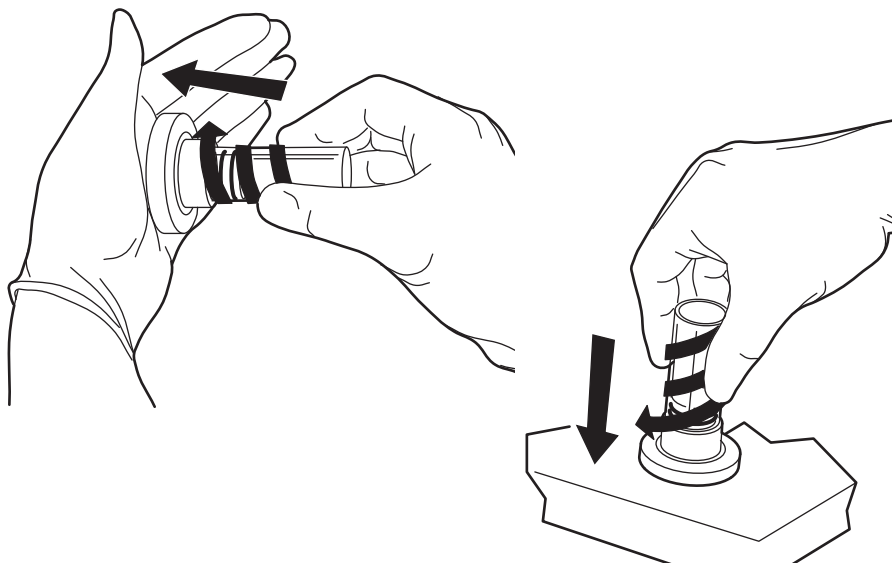

3. Ensure there is no visible gap between the ThinPrep Pap Test Filter and the filter cap as shown in Figure 5A-5.

The ThinPrep Pap Test Filter must seat against the filter cap lip.

Figure 5A-5 Correct filter cap-to-filter assembly

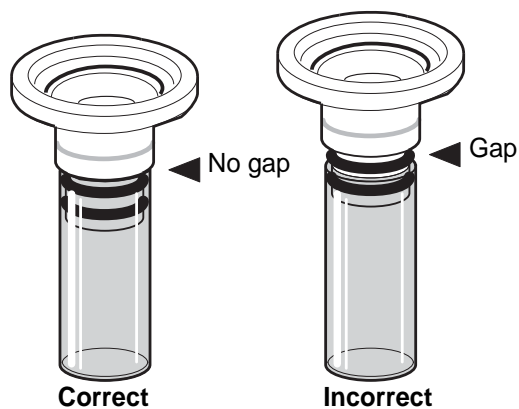

4. Insert the filter assembly into the instrument.

Hold the filter assembly by the ThinPrep Pap Test Filter cylinder and place the angled edges of the filter cap against the two front bobbins as shown in Figure 5A-6.

Figure 5A-6 Positioning the filter cap in the bobbins

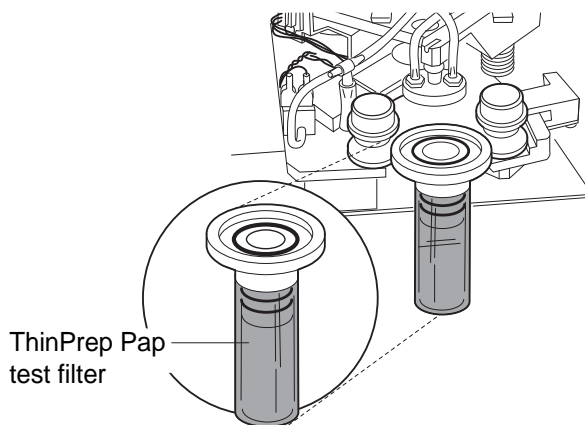

5. Keeping the filter assembly level, push it straight into the instrument. The right bobbin will move to the right as the filter assembly is inserted. The filter assembly is completely seated when the right bobbin moves back to the left and the two front bobbins hold the filter assembly in the processor. Refer to Figure 5A-7.

5A

OPERATING INSTRUCTIONS

When properly loaded, the filter cap is level inside the instrument and the filter cylinder is above the PreservCyt Sample vial and slightly to the left. If the positioning of the filter assembly does not correspond to this description, remove it and try again. The filter assembly will easily rotate in the bobbins when properly seated.

Figure 5A-7 Loading the filter assembly

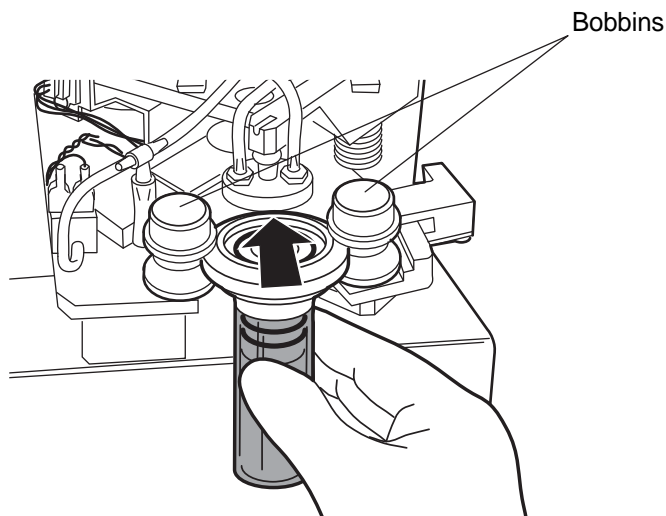

SECTION
H

LOADING THE THINPREP MICROSCOPE SLIDE

1. Label the ThinPrep slide with patient's identification information. Use the frosted area of the slide. When using an adhesive label, ensure that the label is completely adhered to the slide and that there are no overhanging edges.
2. Using two hands, hold the slide by the two front corners with your index fingers and thumbs as shown in Figure 5A-8. Be sure not to touch the slide within the defined screening area. Place the label end to the right and facing down.
3. Insert the slide. Using the slide to push the spring-loaded clamps down, insert the slide halfway under the upper guide block and over the spring-loaded clamps, then release the slide. Refer to Figure 5A-8.

Figure 5A-8 Inserting the slide onto the clamps

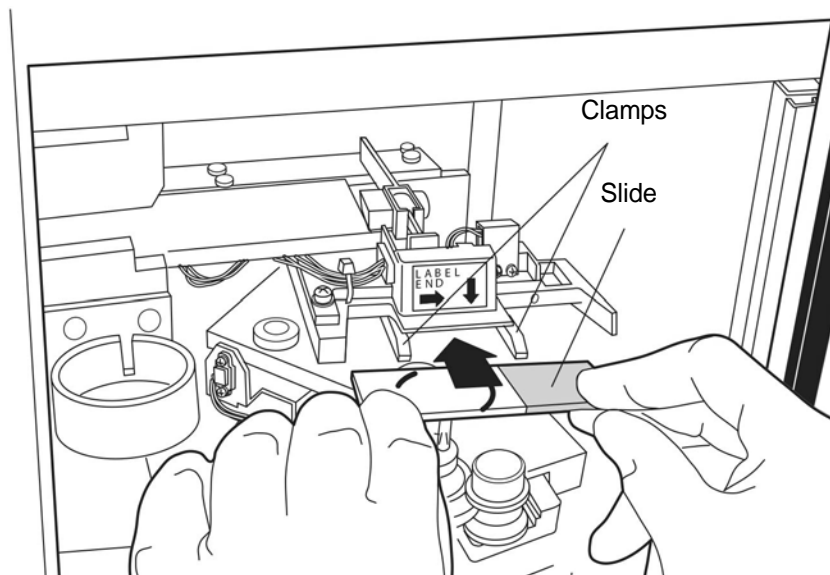

- The slide should now rest on top of the two clamps and under the upper guide block as shown in Figure 5A-9.

Figure 5A-9 Correct/Incorrect slide insertion

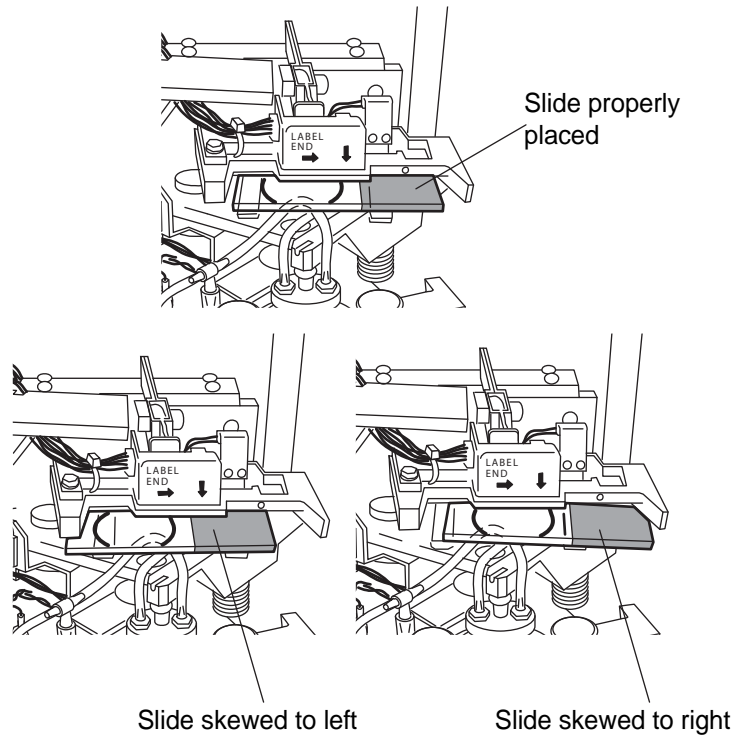

5. To fully insert the slide, place your index fingers against the exposed edge of the slide and push the slide in until it does not go any further, as shown in Figure 5A-10. The slide handler clamps grasp the slide when the slide is seated correctly and the slide moves up slightly behind the upper guide block.

Figure 5A-10 Inserting the slide fully

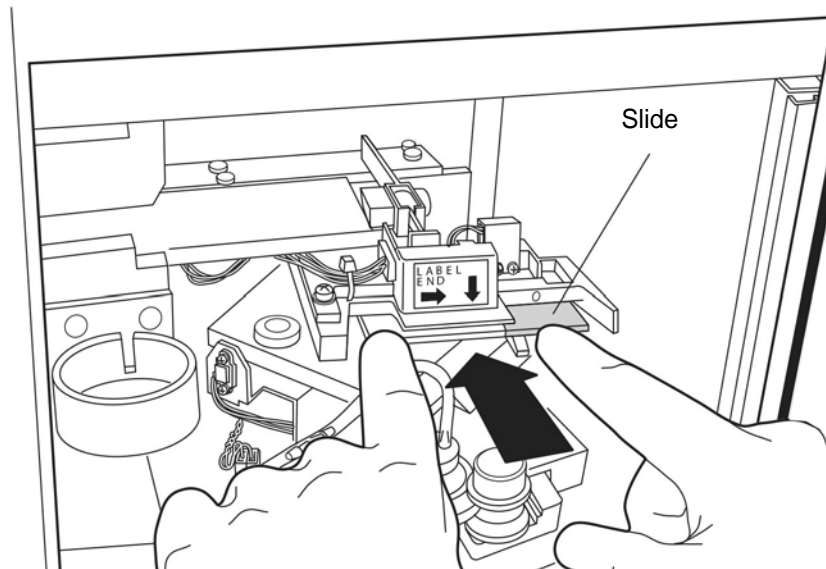

Note: To remove a slide, press down on the front edge of the slide. Gently pull the slide toward you.

SECTION
|

LOADING THE FIXATIVE VIAL

1. Fill a fixative vial with standard laboratory fixative alcohol until the fluid level is between the “MIN” and “MAX” marks on the vial.

If the staining protocol requires alternative fixation methods, leave the fixative vial empty or fill it with the appropriate fixative solution.

Change the contents of the fixative vial at least every 100 slides or daily, whichever occurs first.

2. Place the fixative vial into the fixative bath holder until the bottom of the vial rests on the base of the holder. Refer to Figure 5A-11. Ensure that the fixative vial is completely seated.

Figure 5A-11 Loading the fixative vial

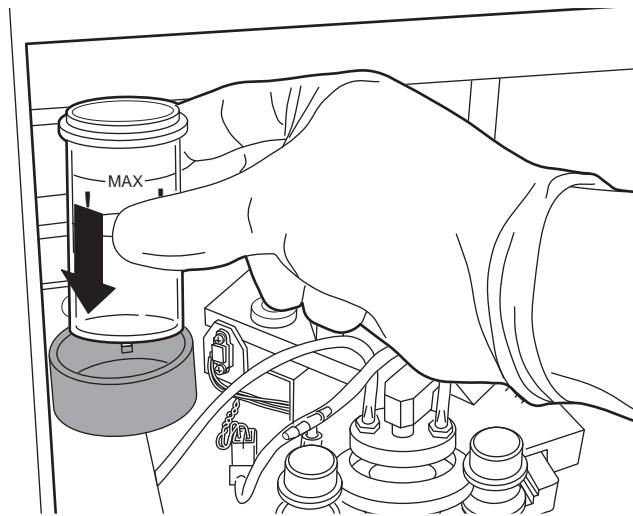

SECTION
J

CLOSING THE DOOR

To close the hinged door, grasp the handle and push the door shut. For instruments with the sliding door, grasp the door tab and slide it completely to the left.

The instrument will not operate if the door is open. The door must never be opened during instrument operation. If the door is opened after processing begins, the sequence will abort. The system will wait until the door is closed before system recovery will occur.

Figure 5A-12 Door opening and closing

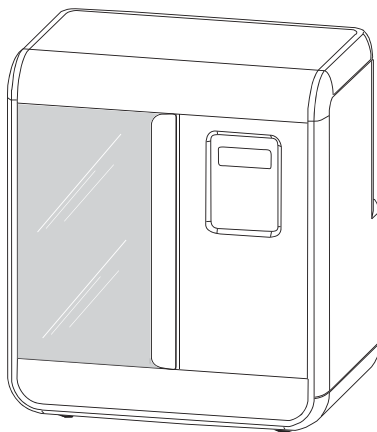

Door closed

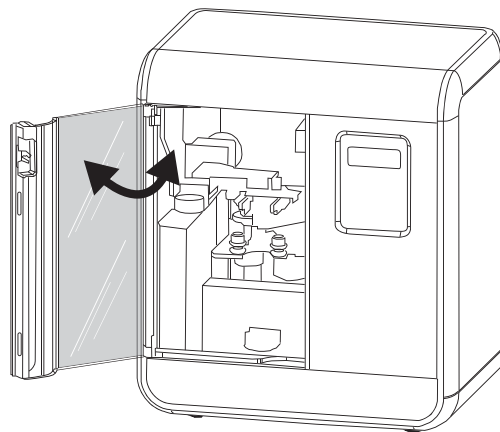

Door open

Note: Use care when opening the hinged door. Using excessive force can damage the door.

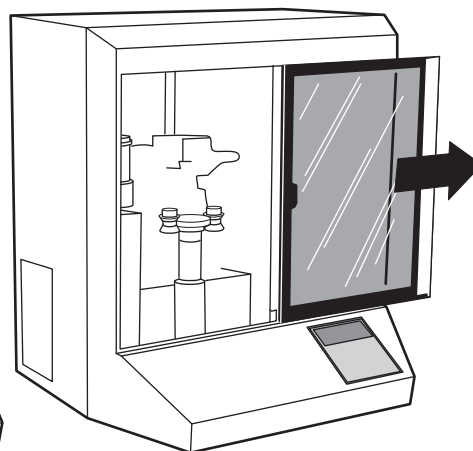
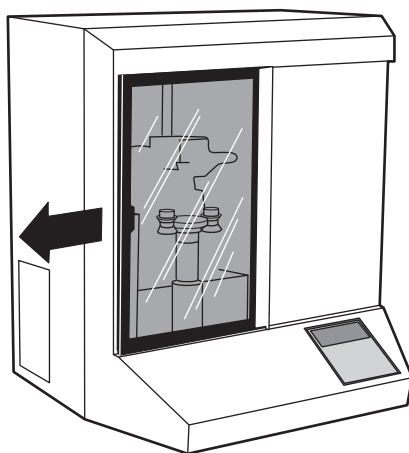

Caution: Do not open the door during processing. Depending on where a sequence is interrupted, cells may be lost or air-dried during recovery.

5A OPERATING INSTRUCTIONS

SECTION K

SELECTING AND INITIATING A SEQUENCE

The ThinPrep 2000 Processor has several program modes in its program card. There are two primary types of modes:

1. Sample processing sequences
2. Diagnostic

The sample processing sequences are used to process different kinds of specimens.

The diagnostic modes are used to display the status of the instrument or to perform maintenance procedures. The Main Menu, shown below, is displayed whenever the instrument is in its idle state.

```
Main Menu: Select
1 - SUPER           4 - GYN
2 - FLU/FNA
3 - MUCOID          ↓ - MORE
```

The Main Menu contains the four sequences for sample processing. To view the diagnostic modes, push the down arrow key and the menu will change to the following:

```
Main Menu: Select
6 - STATUS           8 - TEST
7 - MAINT
STOP - PREVIOUS MENU
```

A description of the sequences is in Table 5A.1.

Table 5A.1: ThinPrep 2000 Processor Sequences and Modes

Key Number	Description
1	SUPERFICIAL SAMPLES Includes non-mucoid, superficial cell samples such as oral cavity samples, nipple secretions, skin lesions (Tzanck Test) and buccal samples.
2	FLUIDS, FNA AND FIRSTCYTE BREAST TEST SAMPLES Includes non-mucoid body cavity fluids and fine needle aspirates.
3	MUCOID SAMPLES Includes sputum samples, bronchial brush and wash samples, and gastrointestinal samples.
4	GYNECOLOGIC SAMPLES Includes cell samples from the ectocervix and the endocervix. Use this sequence for the ThinPrep Pap Test.
6	STATUS
7	MAINTENANCE
8	TEST

To initiate a sample processing sequence, simply press the key corresponding to the desired sequence. The sequence will begin immediately after the key is pressed. If an incorrect sequence is selected, press the STOP key to abort the sequence. At the end of the sequence, the display will return to the Main Menu.

Caution: Do not open the door during processing. Depending on where a sequence is interrupted, cells may be lost or air-dried during recovery.

To view the diagnostic modes, push the down arrow key from the Main Menu and the options will be displayed. To return to the idle mode and the sample processing sequences, push the STOP key. To initiate the diagnostic modes, push the number of the desired option. The diagnostic modes return to the previous screen automatically upon their completion or after the operator pushes the STOP key.

If the ThinPrep 2000 Processor detects an error condition during any sequence, the sequence will abort, the system will attempt to recover and a message will be displayed. Refer to Chapter 6, "Instrument Troubleshooting", for more information.



SECTION
L

UNLOADING THE THINPREP 2000 PROCESSOR

1. Open the door.
2. Remove the fixative vial containing the prepared slide from its holder. It is necessary to remove the fixative vial from the holder after each slide is processed.

Caution: The fixative vial must be removed. Evaporating alcohol could create a fire hazard.

3. Remove the prepared slide from the fixative vial and deposit the slide into a staining rack in a bath containing standard laboratory fixative.

Refer to Chapter 8, “Fixation, Staining, and Coverslipping”, for more information about slide fixation, staining and coverslipping.

4. Using the cross-contamination precautions listed below, remove the filter assembly, and separate the ThinPrep Pap Test Filter from the filter cap (a slight twisting motion may be helpful).

Note: Handle the filter cap gently. Do not hit it against hard surfaces.

Caution: To reduce the possibility of cross-contamination, use one of the following methods to remove the ThinPrep Pap Test Filter from the filter cap:

Method A:

Place a lint-free wipe around the ThinPrep Pap Test Filter to prevent contamination of your gloves while removing the filter assembly from the instrument and while separating the ThinPrep Pap Test Filter from the filter cap. Dispose of the lint-free wipe with the ThinPrep Pap Test Filter.

Method B:

Remove the ThinPrep Pap Test Filter from the filter cap and wipe off your gloves with lint-free wipe to remove any liquid or change your gloves after each slide preparation cycle.

5. Dispose of the used ThinPrep Pap Test Filter cylinder using appropriate laboratory procedures. A **ThinPrep Pap Test Filter must be used only once and cannot be reused.**
6. Remove the PreservCyt sample vial from the instrument and recap it firmly. Be sure to line up the torque line on the cap with the torque line on the vial. Refer to Figure 5A-13. If the cap on the vial does not have a line, ensure the cap is tightened securely.

Figure 5A-13 Capping the PreservCyt sample vial

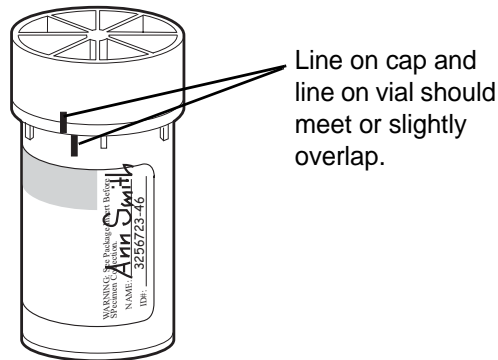

7. Do not discard the sample vial until it has been determined that no additional slides are needed. Refer to Chapter 3, "PreservCyt Solution", for information regarding solution disposal and sample storage.

SECTION
M

INTERRUPTING THE SLIDE PREPARATION PROCESS

Ordinarily, the ThinPrep 2000 Processor slide preparation process should not be interrupted. However, if it is necessary to stop processing for any reason, use the following procedure to ensure the slide is not contaminated with another specimen.

1. Press the STOP key and wait until the display reads, RECOVERY COMPLETE.

The ThinPrep Processor will halt the process with an audible tone and a message indicating that the STOP key was pressed will be displayed. The instrument will automatically recover and return the motors to their starting positions. The system will always attempt to return cellular material on the filter back into the sample vial during error recovery.

2. Press the ENTER key to stop the audible alarm and to return to the Main Menu.
3. Remove the fixative vial if it contains a slide, otherwise remove the ThinPrep Microscope Slide from the slide holder.
4. Remove the filter assembly.
5. Remove the ThinPrep Pap Test Filter from the filter cap if it is wet or damaged. Dispose of the ThinPrep Pap Test Filter using the appropriate laboratory procedures. Refer to “UNLOADING THE THINPREP 2000 PROCESSOR” on page 5A.18, of this chapter.
6. Remove the PreservCyt Sample vial if it is not the correct specimen.

Refer to “LOADING THE PRESERVCYT SAMPLE VIAL” on page 5A.7, earlier in this chapter to restart the process.

**SECTION
N****STATUS, MAINTENANCE, AND TEST SCREENS**

The ThinPrep 2000 Processor has seven different Main Menu options which can be viewed by pressing the up and down arrow keys:

- 1-4: Processing Sequences
- 6: Status
- 7: Maintenance
- 8: Test

“SELECTING AND INITIATING A SEQUENCE” on page 5A.16 of this chapter describes how to initiate the sequences. The purpose of this section is to describe the functions of Status, Maintenance, and Test. By pressing the down arrow key from the Main Menu the following appears:

```
Main Menu: Select
6-STATUS           8-TEST
7-MAINT
STOP - PREVIOUS MENU
```

6 – Status:

Pressing **6** from the Main Menu displays the following screen.

```
Status:
1 - COUNTERS
2 - ERROR HISTORY
3 - FIRMWARE VERSION
```

To return to the Main Menu, press STOP.

1 – Counters:

```
Sequence Counters:
1 - XXXXXX      4 - XXXXXX
2 - XXXXXX
3 - XXXXXX      T - XXXXXX
```

Pressing 1 displays the Sequence Counters. A number is displayed next to each sequence number which identifies the number of cycles for that particular sequence. The value next to the “T” is the total number of cycles on the processor. To return to the Status Menu, press STOP.

2 – Error History:

```
Error History:      ↑↓
# ERROR MINOR CYCLE

XX XX   XX  XXXXXX
```

Pressing 2 displays the Error History screen. The system will store the last 50 error messages that occurred on the processor. Technical Support may ask you to access this screen during troubleshooting. The first column (#) is the counter, 1–50. The second column (ERROR) is the error code. The third column (MINOR) is the minor error number which often provides additional information on the source of the error. The last column (CYCLE) is the total cycle count of the processor when the error occurred. To return to the Status Menu, press STOP.

3 – Firmware Version:

```
Firmware:  
VERSION X.XX  
COMPUTED CRC: XXXX  
FIRMWARE CRC: XXXX
```

Pressing 3 displays the Firmware screen. This screen allows the operator to view the version of the Program Memory Card in use without turning off the power and removing the card. Technical Support may access this screen during troubleshooting.

To return to the Status Menu, press STOP.

7 – Maintenance:

Pressing 7 from the Main Menu displays the following screen.

```
Maintenance:  
1 - LCD ADJUST  
2 - WASTE SYSTEM  
3 - SERVICE MODE
```

To return to the Main Menu, press STOP. The processor must be completely empty of supplies before continuing with Maintenance.

1 – LCD Adjust:

```
LCD Contrast Adjust:
↑: +                (09)
↓: - backlight : 1
ENTER to select
```

Pressing **1** displays the LCD Contrast Adjust screen. A number is displayed in the parentheses from 00 to 15. Use the up and down arrow keys to adjust the contrast to an acceptable level and then press the ENTER key to save the change and to return to the Maintenance Menu.

2 – Waste System:

```
Processing          17
Remove disposables
and vial. Press
ENTER when finished.
```

Pressing **2** initiates the waste system maintenance mode. It is critical to remove the fixative vial, filter, slide, and sample vial before continuing. After pressing ENTER to continue, three things occur:

- *Waste bottle vacuum vents to atmosphere* — The waste bottle vents to allow the operator to more easily remove the cap off the waste bottle for emptying of its contents. See “EMPTYING WASTE BOTTLE” on page 7.2.
- *Rotating plate in processor inverts* — The rotating plate inverts to allow the operator to more easily clean the underside of the cap seal. See “CAP SEAL CLEANING” on page 7.9.
- *Sample vial holder rises* — The sample vial holder rises to allow the operator to more easily clean under the holder. See “GENERAL CLEANING” on page 7.10.

When the maintenance operation is complete, the operator must press ENTER with the door closed to return to the Main Menu.

3 – Service Mode:

Pressing **3** initiates the Service Mode screen. This Service Mode is for Hologic use only. Technical Support may ask you to access this screen during troubleshooting. To return to the Main Menu, press STOP.

8 – Test:

Pressing **8** from the Main Menu displays the following screen. To return to the Main Menu, press STOP.

```
System Test:  
1 - Keypad / Display  
2 - Pneumatic
```

1 – Keypad / Display:

This test is used to confirm proper operation of the keypad and display. Pressing **1** initiates the Keypad / Display Test screen. Press all of the keys on the keypad and confirm that the corresponding character is changed on the display. Press the STOP key last to end the test. If any keys fail to respond, call Hologic Technical Support.

2 – Pneumatic:

This test is used to confirm the proper operation of the entire pneumatic system. Hologic recommends running this 5-minute test on a weekly basis. The results of this test may notify the operator to perform certain maintenance procedures or warn them that instrument service is required.

Pressing **2** prompts the user to load the sealed cylinder, which is the solid plastic model of the Thin-Prep Pap Test Filter, into the instrument. Press ENTER to initiate the test. The test will automatically end if any errors occur and the operator will be notified of the area of concern. Once the problem has been addressed, it is necessary to run the test again to ensure proper operation. If no errors occur, the test will end with a message which indicates a successful test.



PNEUMATIC TESTING

Errors	Action
CAP SEAL LEAK	Clean filter cap & cap seal
WASTE PRESSURE FAILURE	Follow Troubleshooting for Waste Pressure Failure error
ATM VALVE LEAK	Call Hologic Technical Support
QTO VALVE LEAK	Call Hologic Technical Support
POSITIVE PRESSURE FAILURE	Call Hologic Technical Support
NEGATIVE PRESSURE FAILURE	Call Hologic Technical Support
WASTE LINE CLOGGED	Call Hologic Technical Support
- TANK LINE CLOGGED	Call Hologic Technical Support
+ TANK LINE CLOGGED	Call Hologic Technical Support
QTO LINE CLOGGED	Call Hologic Technical Support

Chapter Five B

Operating Instructions for Processing COBAS AMPLICOR™ CT/NG Samples

Note: Refer to Chapter 5A, “Operating Instructions”, if *Chlamydia trachomatis* and *Neisseria gonorrhoeae* testing using the Roche Diagnostics COBAS AMPLICOR CT/NG Test will not be performed on the residual specimen after a slide has been prepared using the ThinPrep 2000 processor.

SECTION

A

INTRODUCTION

This section provides instructions for operating the ThinPrep® 2000 Processor for processing samples requiring microbiological testing using the Roche Diagnostics COBAS AMPLICOR CT/NG Test.

The following topics are covered in this section:

- SECTION B:** Material Requirements
- SECTION C:** Pre-Operation Checklist
- SECTION D:** Overview of Loading the ThinPrep 2000 Processor
- SECTION E:** Preparing the Filter Caps
- SECTION F:** Loading the Fixative Vial
- SECTION G:** Loading the ThinPrep Pap Test Filter
- SECTION H:** Loading the PreservCyt® Sample Vial
- SECTION I:** Loading the ThinPrep Microscope Slide
- SECTION J:** Closing the Door
- SECTION K:** Selecting and Initiating a Sequence
- SECTION L:** Unloading the PreservCyt Sample Vial
- SECTION M:** Unloading the ThinPrep Microscope Slide
- SECTION N:** Unloading the Filter Assembly
- SECTION O:** Interrupting the Slide Preparation Process
- SECTION P:** Status, Maintenance, and Test Screens

SECTION
B

MATERIAL REQUIREMENTS

Figure 5B-1 The required materials

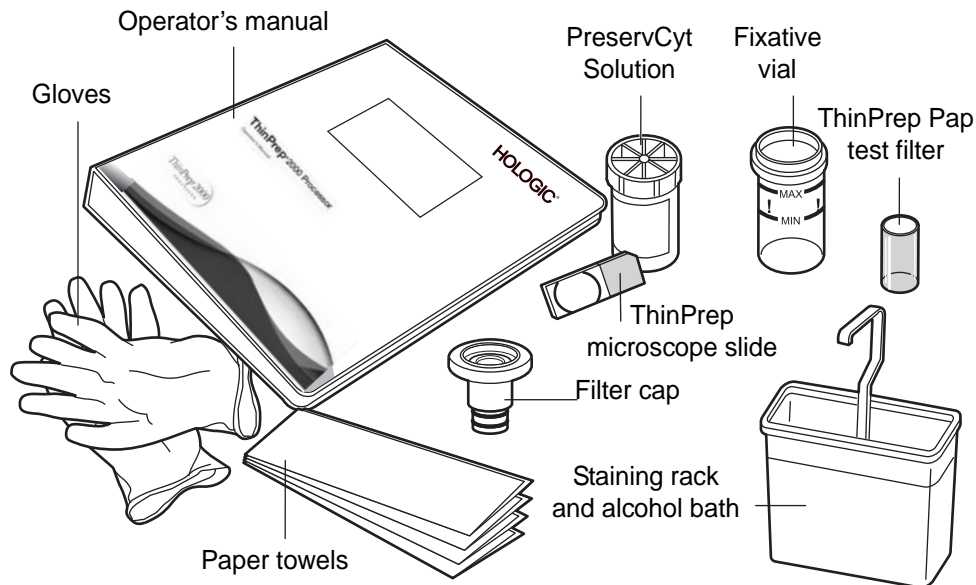

The **PreservCyt Solution** vial is a plastic vial that contains an alcohol-based preservative solution that preserves cells from all body sites for up to three weeks at room temperature. For more information on PreservCyt Solution, refer to Chapter 3, “PreservCyt Solution”.

The **ThinPrep Pap Test Filter** is a disposable plastic cylinder that is open at one end and has a filter membrane bonded onto the other end. The filter membrane has a flat, smooth, porous surface.

The **filter cap** is a plastic cap that fits onto the open end of the ThinPrep Pap Test Filter and mounts the ThinPrep Pap Test Filter into the processor.

The **fixative vial** is a plastic vial that should be filled with standard laboratory fixative alcohol. After the ThinPrep Processor transfers cells onto the slide, it automatically ejects the slide into the fixative vial.

The **ThinPrep Microscope Slide** is a high-quality, pre-cleaned glass microscope slide with a defined screening area and a larger labeling area. The slide is specifically designed for use with the ThinPrep Processor.

Supplies used in the ThinPrep 2000 System are those designed and supplied by Hologic specifically for the ThinPrep 2000 Processor. These include PreservCyt Solution vials for use with the ThinPrep Pap Test, Gyn ThinPrep Pap Test Filters (clear), and ThinPrep Microscope Slides. For gynecologic



use, these supplies are required for proper performance of the system and cannot be substituted with any other items. Product performance will be compromised if other supplies are used. After use, supplies should be disposed of in accordance with local, state, and federal regulations.

The **ThinPrep 2000 System Operator's Manual** contains detailed information about the ThinPrep 2000 System, such as the principles of operation, operating instructions, specifications, and maintenance information. The manual also contains information on the solutions and materials required to prepare slides with the ThinPrep 2000 Processor.

Disposable laboratory gloves — non-powdered gloves are recommended.

Paper Towels.

Alcohol bath with slide staining rack and standard laboratory fixative alcohol.

BloodBloc® Super Absorbent Wipes – 4"×4" (10 x 10 cm).

(Available from Fisher Scientific at www.fisherscientific.com)

Covered Glass Staining Dishes.

Bleach (Clorox® or equivalent) with a concentration of at least 5% sodium hypochlorite.

Distilled Water.



SECTION
C

PRE-OPERATION CHECKLIST

The following conditions should be checked before preparing a slide on the ThinPrep 2000 Processor.

- Waste bottle — Make sure the fluid level of the waste bottle is below the “MAX” fill line of the bottle. Refer to “EMPTYING WASTE BOTTLE” on page 7.2 for emptying instructions.
- Idle mode — Confirm that the instrument is powered on and in idle, or Main Menu, mode. If the Main Menu is not displayed, follow the instructions on the display until the idle mode appears. If the system’s power is off, refer to “TURNING ON YOUR THINPREP 2000 PROCESSOR” on page 2.9, for turning system power on.
- Filter seal O-rings — Make sure that the two O-rings at the base of the filter cap are not dry, cracked, or in need of lubrication. Refer to “FILTER CAP O-RING LUBRICATION” on page 7.5 for lubrication and/or replacement instructions.
- Disposable laboratory gloves — Always wear disposable laboratory gloves and other lab safety garments when operating the ThinPrep Processor. Always begin the process with a clean pair of laboratory gloves.
- Bleach Bath – prepare daily in a covered glass staining dish, a 500mL 10% (volume/volume) bleach solution in distilled water.
- Water bath –In a glass staining dish, add 500mL of distilled water. This bath should be changed after the processing of 20 PreservCyt sample vials.

Place the bleach bath and distilled water bath on the bench close to the TP-2000 processor. Place 2 filter caps in the bleach bath. Ensure the filter caps are completely covered by the bleach. Allow to soak for a minimum of one (1) minute.

Note: The use of two (2) filter caps allows for one to be soaked while the other is in use. Always ensure that a filter cap has soaked a minimum of one (1) minute before using for sample processing.

Note: Once sample has been added to a PreservCyt *Solution* vial, the vial is then designated as a *PreservCyt sample vial*.

SECTION
D

OVERVIEW OF LOADING THE THINPREP® 2000 PROCESSOR

The following sections describe in detail the methods for loading the ThinPrep 2000 Processor. Before initiating a run, the following supplies must be loaded into the processor in the order indicated.

- Fixative Vial
- ThinPrep Pap Test Filter and Filter Cap (filter assembly)
- PreservCyt Sample Vial
- ThinPrep Slide

The figure below shows the ThinPrep 2000 Processor after loading of the supplies is complete.

Figure 5B-2 ThinPrep 2000 Processor loaded with supplies

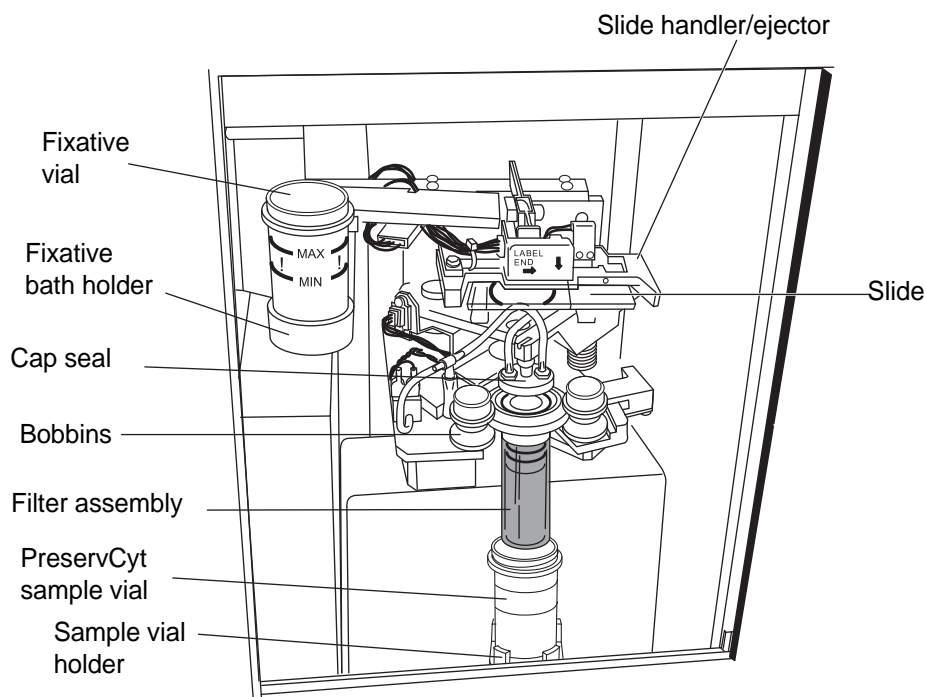



OPERATING INSTRUCTIONS FOR PROCESSING COBAS AMPLICOR™ CT/NG SAMPLES

SECTION E

PREPARING THE FILTER CAPS

1. Put on a clean pair of laboratory gloves. (Figure 5B-3).

Figure 5B-3 Put on clean laboratory gloves

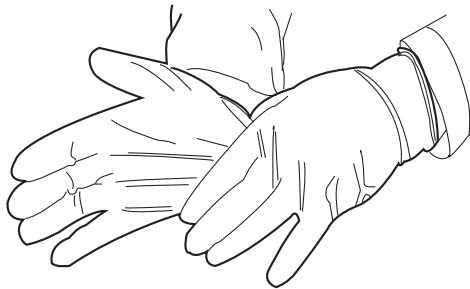

2. Remove one of the filter caps and allow excess bleach to drip from the cap back into the bleach bath.
3. Dip the filter cap into the distilled water bath three (3) times. Ensure the cap is completely covered by the water each time.
4. Dry the cap with paper towel.
5. Place the filter cap with filter seal O-Rings facing upward on a clean 4"x4" (10 x 10 cm) BloodBloc Super Absorbent Wipe. The filter O-rings should be lightly greased. Refer to "FILTER CAP O-RING LUBRICATION" on page 7.5.
6. If the O-Rings were greased, change to a clean pair of laboratory gloves.

SECTION
F

LOADING THE FIXATIVE VIAL

Completely open the ThinPrep 2000 Processor door.

1. Fill a fixative vial with standard laboratory fixative alcohol until the fluid level is between the “MIN” and “MAX” marks on the vial.

If the staining protocol requires alternative fixation methods, leave the fixative vial empty or fill it with the appropriate fixative solution.

Change the contents of the fixative vial at least every 100 slides or daily, whichever occurs first.

2. Place the fixative vial into the fixative bath holder until the bottom of the vial rests on the base of the holder. Refer to Figure 5B-4. Ensure that the fixative vial is completely seated.

Figure 5B-4 Loading the fixative vial

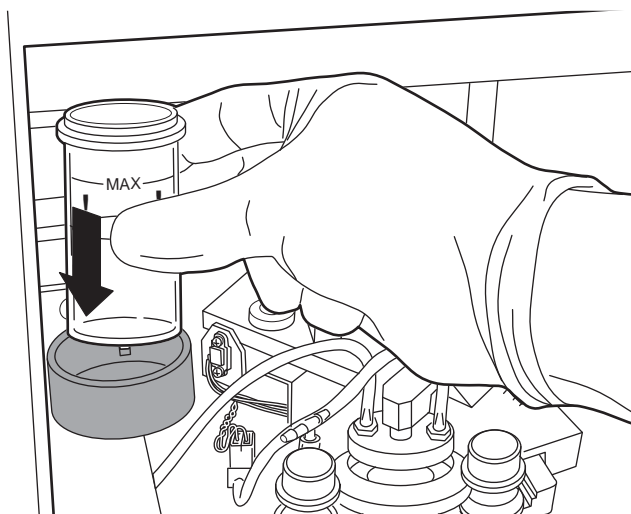

SECTION
G

LOADING THE THINPREP PAP TEST FILTER

1. Remove a new ThinPrep Pap Test Filter from the storage tray by grasping the sides of the cylinder

Caution: Never touch the filter membrane of the ThinPrep Pap Test Filter.

The technique for mating the ThinPrep Pap Test Filter and filter cap is described below. The configuration of the two parts is called a filter assembly. See Figure 5B-5.

Note: Handle the filter cap gently. Do not hit it against hard surfaces.

2. Using the filter cap on the BloodBloc Super Absorbent Wipe prepared in Section E, hold the ThinPrep Pap Test Filter in one hand and insert the ThinPrep Pap Test Filter onto the filter cap. Using a slight twisting motion will prevent unwanted O-ring roll. The filter seal O-rings should be slightly greased. Refer to “FILTER CAP O-RING LUBRICATION” on page 7.5.
3. Ensure there is no visible gap between the ThinPrep Pap Test Filter and the filter cap as shown in Figure 5B-5.

The ThinPrep Pap Test Filter must seat against the filter cap lip.

Figure 5B-5 Correct filter cap-to-filter assembly

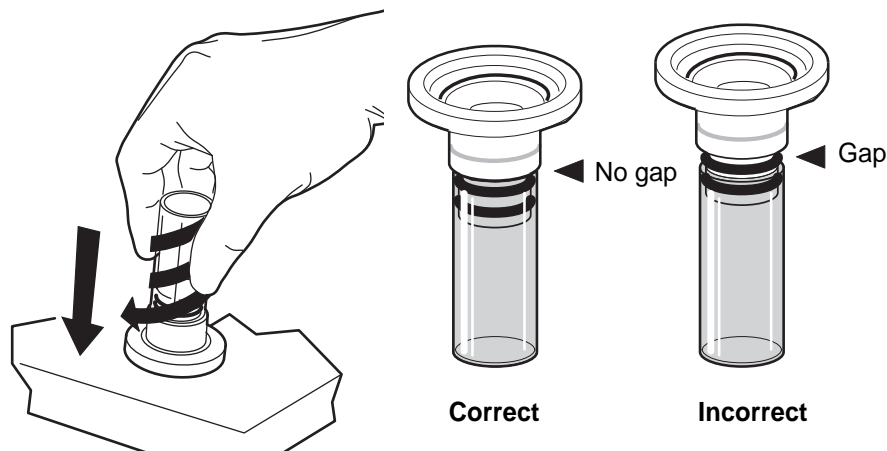

4. Insert the filter assembly into the instrument.

Hold the filter assembly by the ThinPrep Pap Test Filter cylinder and place the angled edges of the filter cap against the two front bobbins as shown in Figure 5B-6.

Figure 5B-6 Positioning the filter cap in the bobbins

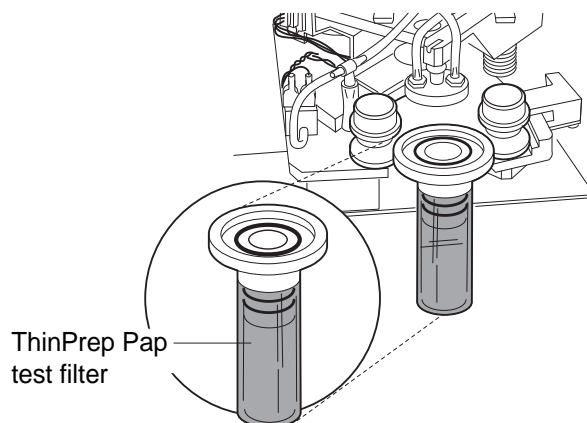

5. Keeping the filter assembly level, push it straight into the instrument. The right bobbin will move to the right as the filter assembly is inserted. The filter assembly is completely seated when the right bobbin moves back to the left and the two front bobbins hold the filter assembly in the processor. Refer to Figure 5B-7.

When properly loaded, the filter cap is level inside the instrument and the filter cylinder is above the PreservCyt Sample vial holder and slightly to the left. If the positioning of the filter assembly does not correspond to this description, remove it and try again. The filter assembly will easily rotate in the bobbins when properly seated.

Figure 5B-7 Loading the filter assembly

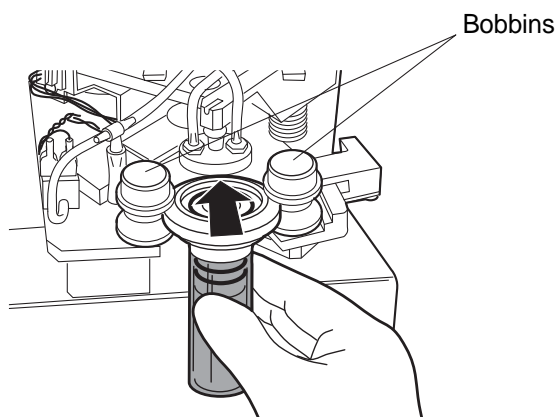



OPERATING INSTRUCTIONS FOR PROCESSING COBAS AMPLICOR™ CT/NG SAMPLES

SECTION H

LOADING THE PRESERVACYT SAMPLE VIAL

1. Confirm that the sample holder and slide handler are empty.
2. Remove the cap from the PreservCyt sample vial. Place vial cap with threads facing upward on lab bench.
3. Gently tilt the PreservCyt sample vial into the sample holder until the bottom of the vial rests on the sample holder base. Refer to Figure 5B-8. Use caution not to spill the contents of the vial. If a spill occurs, use standard laboratory clean up procedures.
4. The vial will remain loose in the sample holder until the process begins. The instrument will automatically grasp the vial during processing.

Figure 5B-8 Loading the PreservCyt sample vial

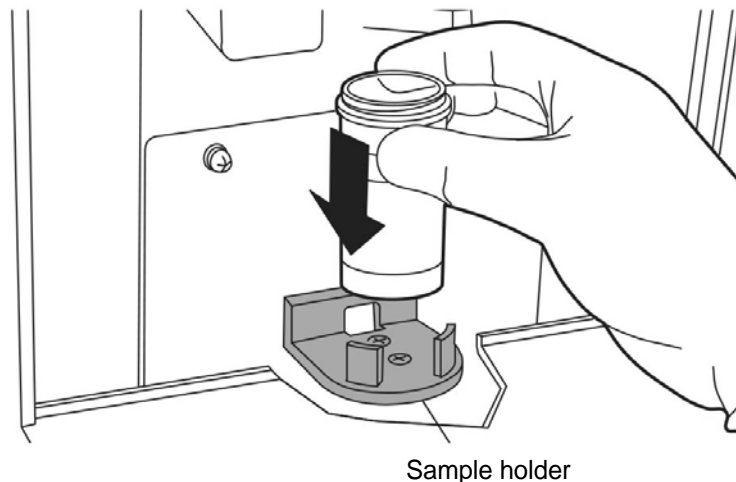

SECTION
|

LOADING THE THINPREP MICROSCOPE SLIDE

1. Label the ThinPrep slide with patient's identification information. Use the frosted area of the slide. When using an adhesive label, ensure that the label is completely adhered to the slide and that there are no overhanging edges.
2. Using two hands, hold the slide by the two front corners with your index fingers and thumbs as shown in Figure 5B-9. Be sure not to touch the slide within the defined screening area. Place the label end to the right and facing down.
3. Insert the slide. Using the slide to push the spring-loaded clamps down, insert the slide halfway under the upper guide block and over the spring-loaded clamps, then release the slide. Refer to Figure 5B-9.

Figure 5B-9 Inserting the slide onto the clamps

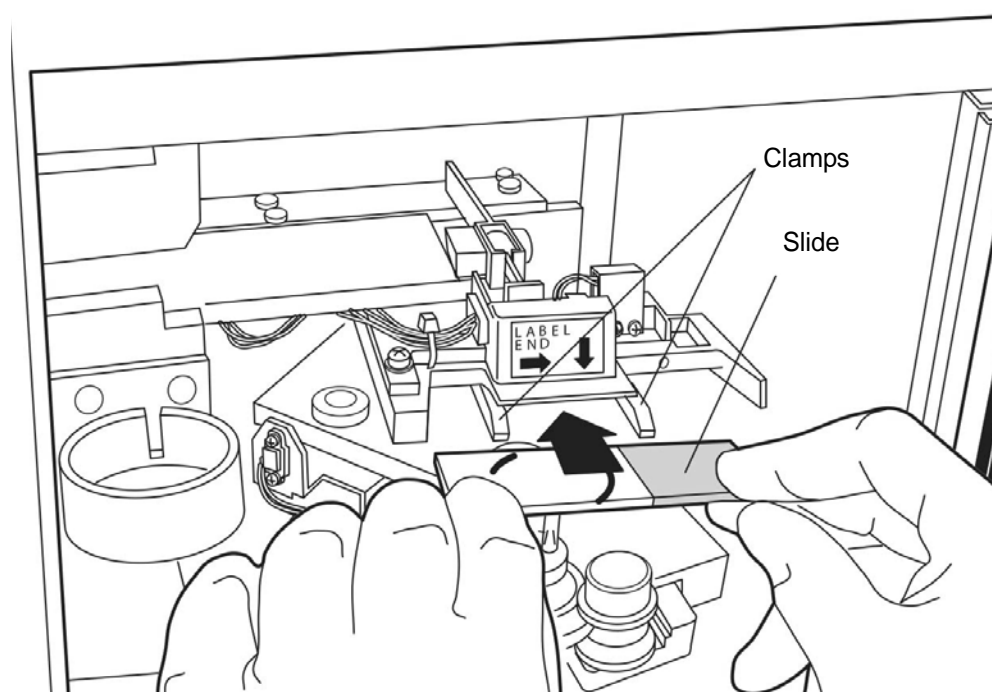



OPERATING INSTRUCTIONS FOR PROCESSING COBAS AMPLICOR™ CT/NG SAMPLES

4. The slide should now rest on top of the two clamps and under the upper guide block as shown in Figure 5B-10.

Figure 5B-10 Correct/Incorrect slide insertion

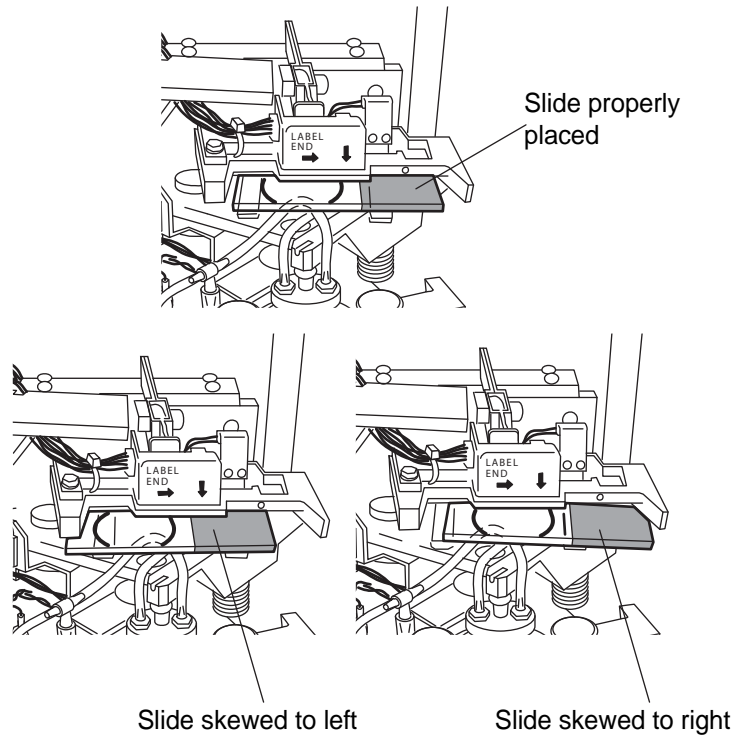

5. To fully insert the slide, place your index fingers against the exposed edge of the slide and push the slide in until it does not go any further, as shown in Figure 5B-11. The slide handler clamps grasp the slide when the slide is seated correctly and the slide moves up slightly behind the upper guide block.

Figure 5B-11 Inserting the slide fully

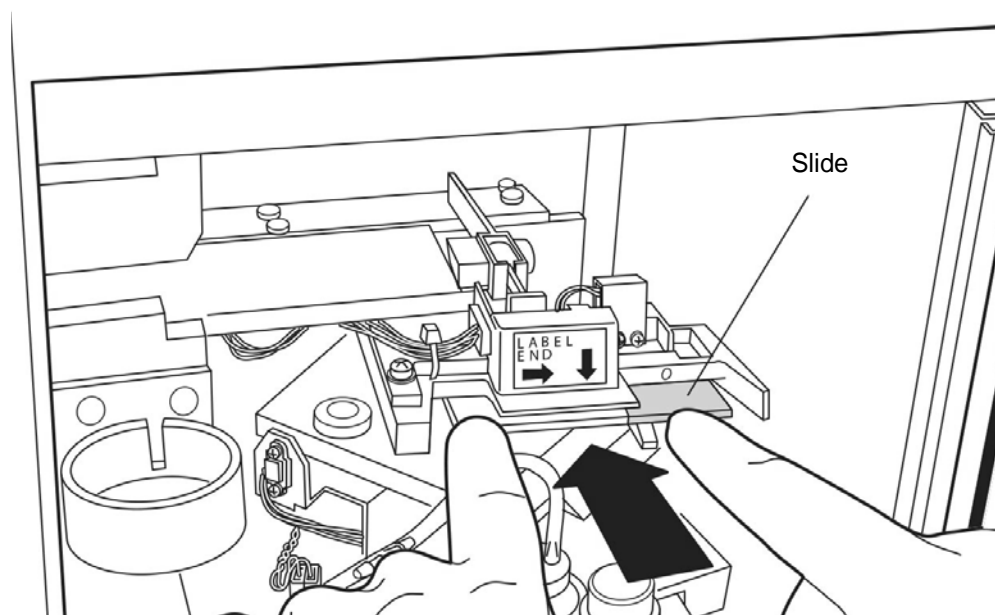

Note: To remove a slide, press down on the front edge of the slide. Gently pull the slide toward you.

5B

OPERATING INSTRUCTIONS FOR PROCESSING COBAS AMPLICOR™ CT/NG SAMPLES

SECTION J

CLOSING THE DOOR

To close the hinged door, grasp the handle and push the door shut. For instruments with the sliding door, grasp the door tab and slide it completely to the left.

The instrument will not operate if the door is open. The door must never be opened during instrument operation. If the door is opened after processing begins, the sequence will abort. The system will wait until the door is closed before system recovery will occur.

Figure 5B-12 Door opening and closing

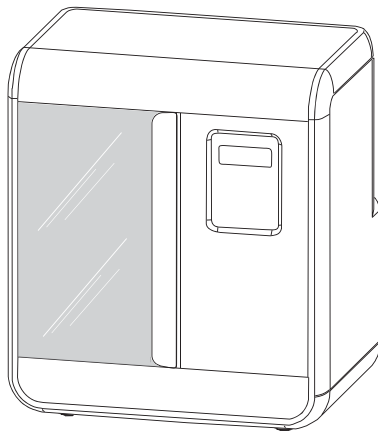

Door closed

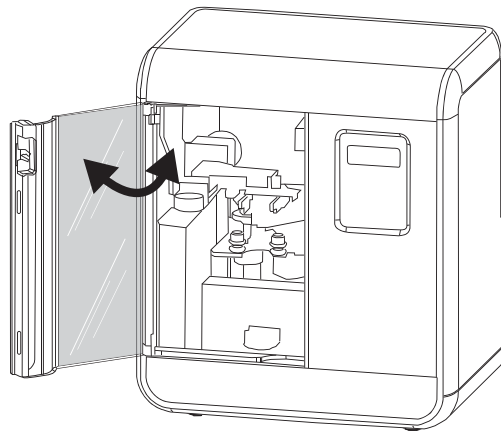

Door open

Note: Use care when opening the hinged door. Using excessive force can damage the door.

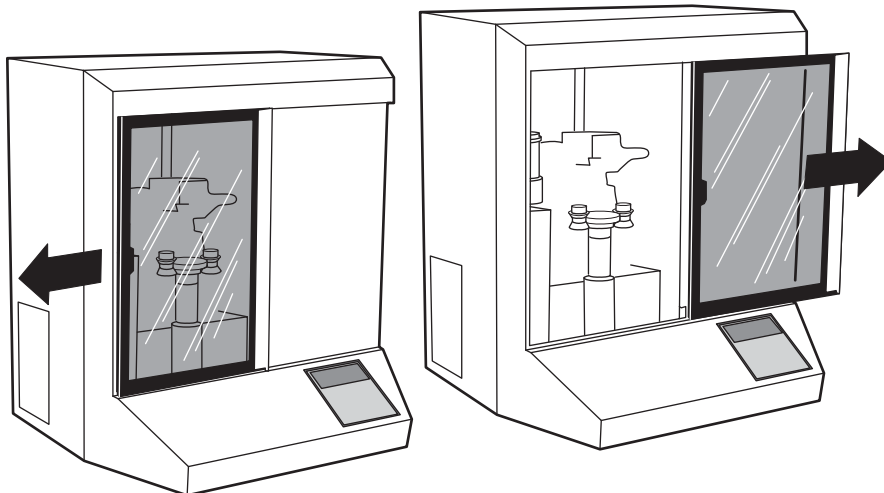

Caution: Do not open the door during processing. Depending on where a sequence is interrupted, cells may be lost or air-dried during recovery.

SECTION
K

SELECTING AND INITIATING A SEQUENCE

The ThinPrep 2000 Processor has several program modes in its program card. There are two primary types of modes:

1. Sample processing sequences
2. Diagnostic

The sample processing sequences are used to process different kinds of specimens.

The diagnostic modes are used to display the status of the instrument or to perform maintenance procedures. The Main Menu, shown below, is displayed whenever the instrument is in its idle state.

```
Main Menu: Select
1 - SUPER           4 - GYN
2 - FLU/FNA
3 - MUCOID          ↓ - MORE
```

The Main Menu contains the four sequences for sample processing. To view the diagnostic modes, push the down arrow key and the menu will change to the following:

```
Main Menu: Select
6 - STATUS          8 - TEST
7 - MAINT
STOP - PREVIOUS MENU
```

A description of the sequences is in Table 5B.1.



Table 5B.1: ThinPrep 2000 Processor Sequences and Modes

Key Number	Description
1	SUPERFICIAL SAMPLES Includes non-mucoid, superficial cell samples such as oral cavity samples, nipple secretions, skin lesions (Tzanck Test) and buccal samples.
2	FLUIDS, FNA AND FIRSTCYTE BREAST TEST SAMPLES Includes non-mucoid body cavity fluids and fine needle aspirates.
3	MUCOID SAMPLES Includes sputum samples, bronchial brush and wash samples, and gastrointestinal samples.
4	GYNECOLOGIC SAMPLES Includes cell samples from the ectocervix and the endocervix. Use this sequence for the ThinPrep Pap Test.
6	STATUS
7	MAINTENANCE
8	TEST

To initiate a sample processing sequence, simply press the key corresponding to the desired sequence. The sequence will begin immediately after the key is pressed. If an incorrect sequence is selected, press the STOP key to abort the sequence. At the end of the sequence, the display will return to the Main Menu.

Caution: Do not open the door during processing. Depending on where a sequence is interrupted, cells may be lost or air-dried during recovery.



To view the diagnostic modes, push the down arrow key from the Main Menu and the options will be displayed. To return to the idle mode and the sample processing sequences, push the STOP key. To initiate the diagnostic modes, push the number of the desired option. The diagnostic modes return to the previous screen automatically upon their completion or after the operator pushes the STOP key.

If the ThinPrep 2000 Processor detects an error condition during any sequence, the sequence will abort, the system will attempt to recover and a message will be displayed. Refer to Chapter 6, "Instrument Troubleshooting", for more information.

Caution: The only processing sequence to be used for processing samples requiring Microbiological Testing Using the Roche Diagnostics COBAS/AMPLICOR CT/NG Test is # 4- GYN.



OPERATING INSTRUCTIONS FOR PROCESSING COBAS AMPLICOR™ CT/NG SAMPLES

SECTION L

UNLOADING THE PRESERVCYT SAMPLE VIAL

1. Open the door.
2. Remove the PreservCyt sample vial from the instrument and recap it firmly. Be sure to line up the torque line on the cap with the torque line on the vial. Refer to Figure 5B-13. If the cap on the vial does not have a line, ensure the cap is tightened securely.

Figure 5B-13 Capping the PreservCyt Vial

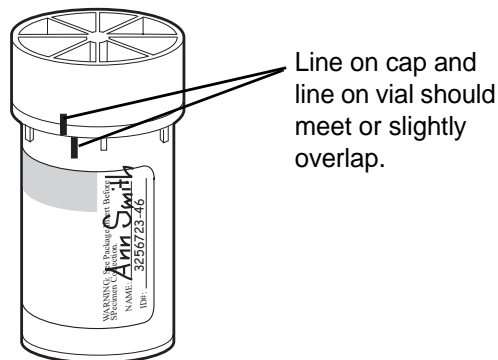

3. Do not discard the sample vial until it has been determined that no additional slides are needed. Refer to Chapter 3, "PreservCyt Solution", for information regarding solution disposal and sample storage.

SECTION
M

UNLOADING THE THINPREP MICROSCOPE SLIDE

1. Remove the fixative vial containing the prepared slide from its holder. It is necessary to remove the fixative vial from the holder after each slide is processed.

Caution: The fixative vial must be removed. Evaporating alcohol could create a fire hazard.

2. Remove the prepared slide from the fixative vial and deposit the slide into a staining rack in a bath containing standard laboratory fixative. Refer to Chapter 8, "Fixation, Staining, and Cover-slipping", for more information about the slide fixation and staining.
3. Return the fixative vial to its holder.

SECTION
N

UNLOADING THE FILTER ASSEMBLY

1. Remove the filter assembly using a clean BloodBloc Super Absorbent Wipe. Grasp the filter and pull the filter assembly forward through the bobbins. Refer to Figure 5B-14.

Note: Handle the filter cap gently. Do not hit it against hard surfaces.

Figure 5B-14 Removing the filter assembly

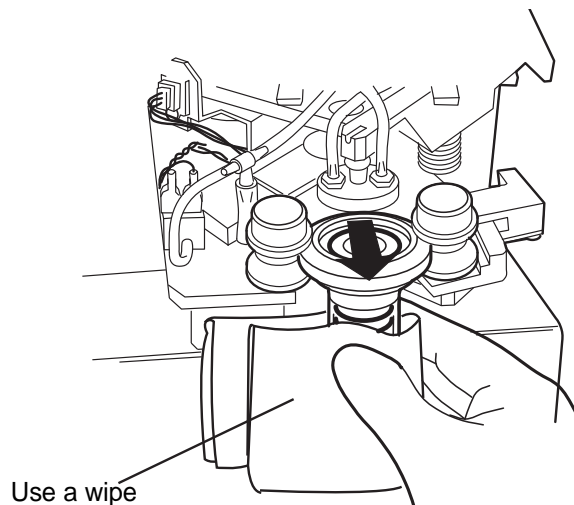

2. Using the opposite hand, grasp the filter cap and separate the ThinPrep Pap Test Filter from the filter cap using a slight twisting motion.
3. Dispose of the BloodBloc Super Absorbent Wipe and the ThinPrep Pap Test Filter cylinder using appropriate laboratory procedures.

Caution: A ThinPrep Pap Test Filter must be used only once and cannot be reused.

4. Using the hand that removed the filter, remove the cover from the bleach bath, and place the used filter cap into the bleach, ensure that the cap is completely covered by the bleach.
5. Discard gloves.

Note: For next sample processed, do not use the filter cap just returned to the bleach bath, unless it has been soaking for a minimum of one (1) minute.

SECTION
O

INTERRUPTING THE SLIDE PREPARATION PROCESS

Ordinarily, the ThinPrep 2000 Processor slide preparation process should not be interrupted. However, if it is necessary to stop processing for any reason, use the following procedure to ensure the slide is not contaminated with another specimen.

1. Press the STOP key and wait until the display reads, RECOVERY COMPLETE.

The ThinPrep Processor will halt the process with an audible tone and a message indicating that the STOP key was pressed will be displayed. The instrument will automatically recover and return the motors to their starting positions. The system will always attempt to return cellular material on the filter back into the sample vial during error recovery.

2. Press the ENTER key to stop the audible alarm and to return to the Main Menu.
3. Remove the fixative vial if it contains a slide, otherwise remove the ThinPrep Slide from the slide holder.
4. Remove the filter assembly.
5. Remove the ThinPrep Pap Test Filter from the filter cap if it is wet or damaged. Dispose of the ThinPrep Pap Test Filter using the appropriate laboratory procedures. Refer to “UNLOADING THE FILTER ASSEMBLY” on page 5B.20, of this chapter.
6. Remove the PreservCyt Sample vial if it is not the correct specimen.

Refer to “LOADING THE PRESERVCYT SAMPLE VIAL” on page 5B.10, earlier in this chapter to restart the process.



SECTION
P

STATUS, MAINTENANCE, AND TEST SCREENS

The ThinPrep 2000 Processor has seven different Main Menu options which can be viewed by pressing the up and down arrow keys:

- 1-4: Processing Sequences
- 6: Status
- 7: Maintenance
- 8: Test

“SELECTING AND INITIATING A SEQUENCE” on page 5B.15 of this chapter describes how to initiate the sequences. The purpose of this section is to describe the functions of Status, Maintenance, and Test. By pressing the down arrow key from the Main Menu the following appears:

```
Main Menu: Select
6-STATUS          8-TEST
7-MAINT
STOP - PREVIOUS MENU
```

6 – Status:

Pressing 6 from the Main Menu displays the following screen.

```
Status:
1 - COUNTERS
2 - ERROR HISTORY
3 - FIRMWARE VERSION
```

To return to the Main Menu, press STOP.



1 – Counters:

```
Sequence Counters:  
1 - XXXXXX      4 - XXXXXX  
2 - XXXXXX  
3 - XXXXXX      T - XXXXXX
```

Pressing 1 displays the Sequence Counters. A number is displayed next to each sequence number which identifies the number of cycles for that particular sequence. The value next to the "T" is the total number of cycles on the processor. To return to the Status Menu, press STOP.

2 – Error History:

```
Error History:      ↑↓  
# ERROR MINOR CYCLE  
  
XX XX   XX  XXXXXX
```

Pressing 2 displays the Error History screen. The system will store the last 50 error messages that occurred on the processor. Technical Support may ask you to access this screen during troubleshooting. The first column (#) is the counter, 1–50. The second column (ERROR) is the error code. The third column (MINOR) is the minor error number which often provides additional information on the source of the error. The last column (CYCLE) is the total cycle count of the processor when the error occurred. To return to the Status Menu, press STOP.

3 – Firmware Version:

```
Firmware:  
VERSION X.XX  
COMPUTED CRC: XXXX  
FIRMWARE CRC: XXXX
```

Pressing 3 displays the Firmware screen. This screen allows the operator to view the version of the Program Memory Card in use without turning off the power and removing the card. Technical Support may access this screen during troubleshooting.

To return to the Status Menu, press STOP.

7 – Maintenance:

Pressing 7 from the Main Menu displays the following screen.

```
Maintenance:  
1 - LCD ADJUST  
2 - WASTE SYSTEM  
3 - SERVICE MODE
```

To return to the Main Menu, press STOP. The processor must be completely empty of supplies before continuing with Maintenance.



1 – LCD Adjust:

```
LCD Contrast Adjust:  
↑: + (09)  
↓: - backlight : 1  
ENTER to select
```

Pressing 1 displays the LCD Contrast Adjust screen. A number is displayed in the parentheses from 00 to 15. Use the up and down arrow keys to adjust the contrast to an acceptable level and then press the ENTER key to save the change and to return to the Maintenance Menu.

2 – Waste System:

```
Processing 17  
Remove disposables  
and vial. Press  
ENTER when finished.
```

Pressing 2 initiates the waste system maintenance mode. It is critical to remove the fixative vial, filter, slide, and sample vial before continuing. After pressing ENTER to continue, three things occur:

- *Waste bottle vacuum vents to atmosphere* — The waste bottle vents to allow the operator to more easily remove the cap off the waste bottle for emptying of its contents. See “EMPTYING WASTE BOTTLE” on page 7.2.
- *Rotating plate in processor inverts* — The rotating plate inverts to allow the operator to more easily clean the underside of the cap seal. See “CAP SEAL CLEANING” on page 7.9.
- *Sample vial holder rises* — The sample vial holder rises to allow the operator to more easily clean under the holder. See “GENERAL CLEANING” on page 7.10.

When the maintenance operation is complete, the operator must press ENTER with the door closed to return to the Main Menu.

3 – Service Mode:

Pressing 3 initiates the Service Mode screen. This Service Mode is for Hologic use only. Technical Support may ask you to access this screen during troubleshooting. To return to the Main Menu, press STOP.

8 – Test:

Pressing 8 from the Main Menu displays the following screen. To return to the Main Menu, press STOP.

```
System Test:  
1 - Keypad / Display  
2 - Pneumatic
```

1 – Keypad / Display:

This test is used to confirm proper operation of the keypad and display. Pressing 1 initiates the Keypad / Display Test screen. Press all of the keys on the keypad and confirm that the corresponding character is changed on the display. Press the STOP key last to end the test. If any keys fail to respond, call Hologic Technical Support.

2 – Pneumatic:

This test is used to confirm the proper operation of the entire pneumatic system. Hologic recommends running this 5-minute test on a weekly basis. The results of this test may notify the operator to perform certain maintenance procedures or warn them that instrument service is required.

Pressing 2 prompts the user to load the sealed cylinder, which is the solid plastic model of the Thin-Prep Pap Test Filter, into the instrument. Press ENTER to initiate the test. The test will automatically end if any errors occur and the operator will be notified of the area of concern. Once the problem has been addressed, it is necessary to run the test again to ensure proper operation. If no errors occur, the test will end with a message which indicates a successful test.

**6. Instrument
Troubleshooting**

**6. Instrument
Troubleshooting**

Chapter Six

Instrument Troubleshooting

SECTION
A

INTRODUCTION

This section provides detailed troubleshooting procedures for problems that may occur during slide preparation. The procedures in this section are designed to help the operator to identify and correct the most common causes of error messages. If the problem cannot be corrected by the operator, these procedures can help Hologic Technical Support to quickly identify the problem.



INSTRUMENT TROUBLESHOOTING

SECTION B

HOW TO USE THIS SECTION

This section lists all the ThinPrep® 2000 Processor messages. The messages are divided into warnings and errors. The description of each message includes a reason for the message, possible causes, and a troubleshooting flowchart.

Follow the three-step procedure listed below for any displayed message.

1. Record the message displayed on the ThinPrep 2000 Processor display panel before pressing the ENTER key.
2. Look up the message in the Contents listed on page 6.3.
(If an error message is displayed that is not in this list, the error cannot be corrected by the operator. Contact Hologic Technical Support.)
3. Follow the instructions in the troubleshooting procedure flowchart.

CONTENTS

WARNINGS	PAGE
Close Door to Continue Processing	6.4
Insert Fix Bath to Continue Processing	6.6
Insert Slide to Continue Processing	6.8
Remove Filter	6.10
Remove Fix Bath	6.12
Remove Slide	6.14
Remove Fix Bath to Continue Processing	6.16
Remove Slide to Continue Processing	6.18
Sample Is Dilute	6.20
OPERATING ERRORS	PAGE
Evacuation Failure. Check Filter	6.22
Filter Already Wet	6.24
No Fluid Detected. Check Filter and Vial	6.26
Sample Too Dense. Dilute 20:1 (for Non-Gyn only)	6.28
Vial Too Full. 21 ml Max. Allowed	6.30
Waste System Failure	6.32
OPERATOR ERRORS	PAGE
Door Open While Processing Sample	6.34
Press ENTER With Door Closed to Retry Initialization. System Uninitialized.	6.35
Stop Key Pressed	6.36
Error History	6.37



Close Door to Continue Processing

Reason for Message

This message appears when the instrument has detected an open door condition during processing or error recovery. The processor will pause until the door is closed.

Possible Causes

- Door opened during processing or error recovery.
- Door not fully closed due to obstruction.
- System hardware malfunction.

Procedure

See flowchart on next page.

Close Door to Continue Processing

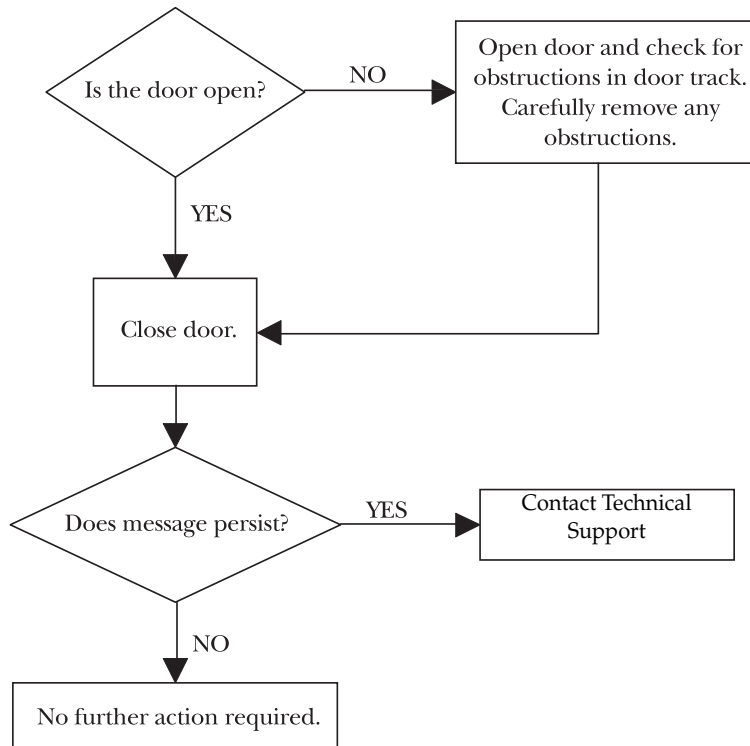



Insert Fix Bath to Continue Processing

Reason for Message

This message appears when the instrument does not detect the presence of the fixative vial. The processor will pause until the operator corrects the situation.

Note: The processor can only detect the presence or absence of a fixative vial. It cannot determine if the fixative vial contains fixative solution.

Possible Causes

- Fixative bath not installed.
- Fixative bath improperly installed due to obstruction.
- System hardware malfunction.

Procedure

See flowchart on next page.

Insert Fix Bath to Continue Processing

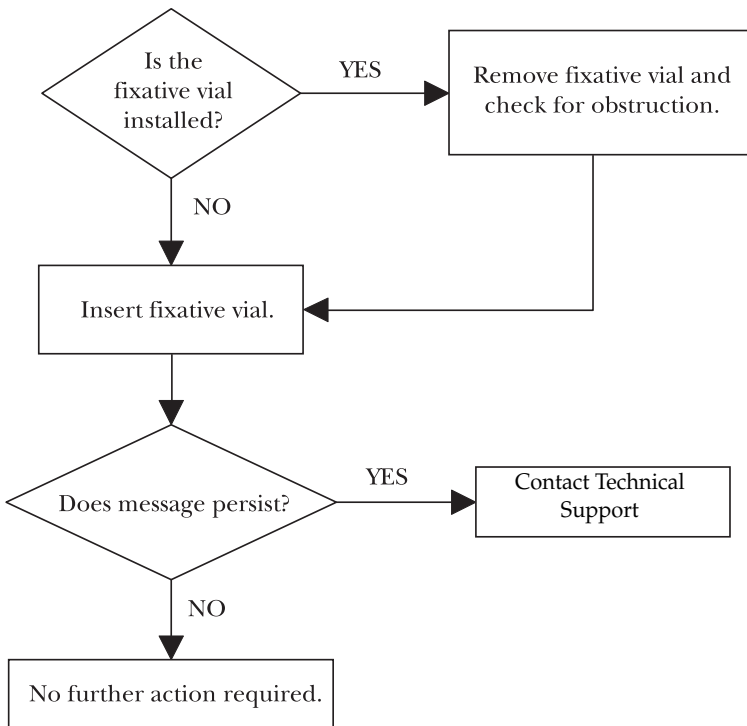



Insert Slide to Continue Processing

Reason for Message

This message appears when the instrument cannot detect the presence of a slide in the slide holder at the start of a sequence. The processor will pause until the operator corrects the situation.

Possible Causes

- Slide not installed.
- Slide improperly installed due to obstruction.
- System hardware malfunction.

Procedure

See flowchart on next page.

Insert Slide to Continue Processing

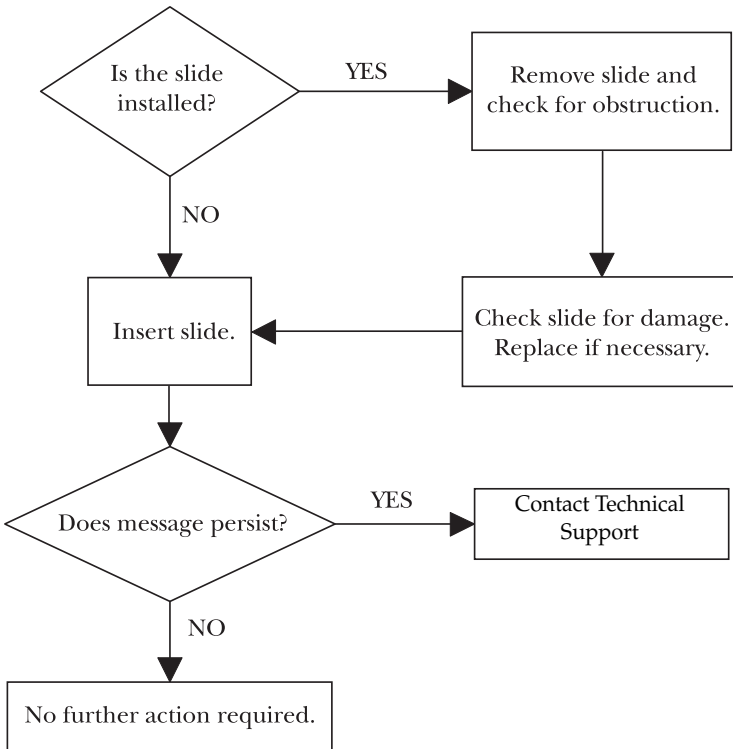



Remove Filter

Reason for Message

This message appears when the instrument has completed processing a slide and the filter assembly has not been removed from the processor. The processor will pause until the operator corrects the situation.

Possible Causes

- Filter not removed after last sequence.
- Error recovery requires filter removal.
- Filter cap was not removed by withdrawing it straight out of the bobbins.

Procedure

See flowchart on next page.

Remove Filter

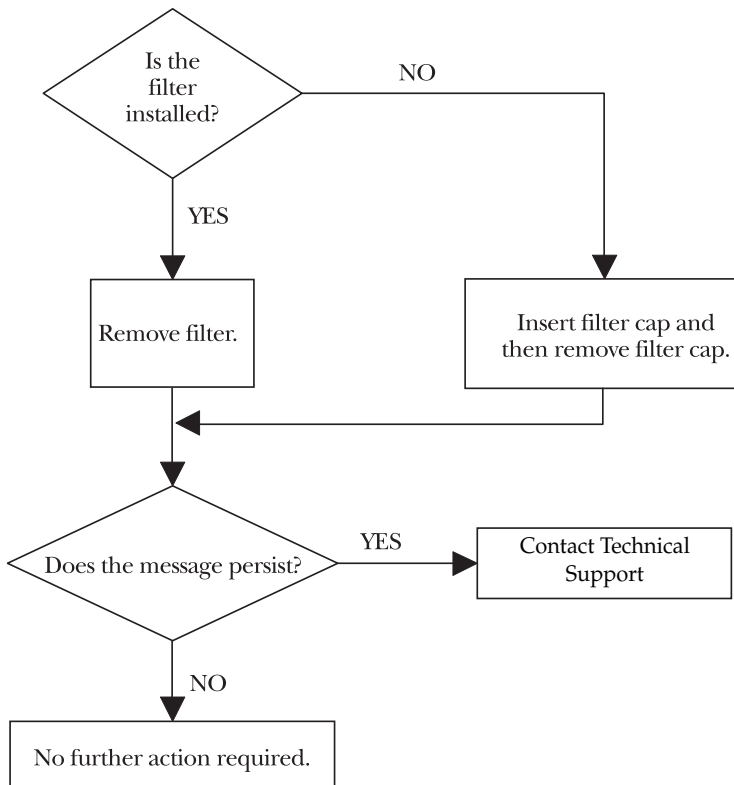



Remove Fix Bath

Reason for Message

This message appears when the instrument has completed processing a slide and a slide has been deposited into the fixative vial. The processor will pause until the operator corrects the situation.

Possible Causes

- Fixative vial never removed after completed sequence.
- System powered on with fixative vial installed.

Procedure

See flowchart on next page.

Remove Fix Bath

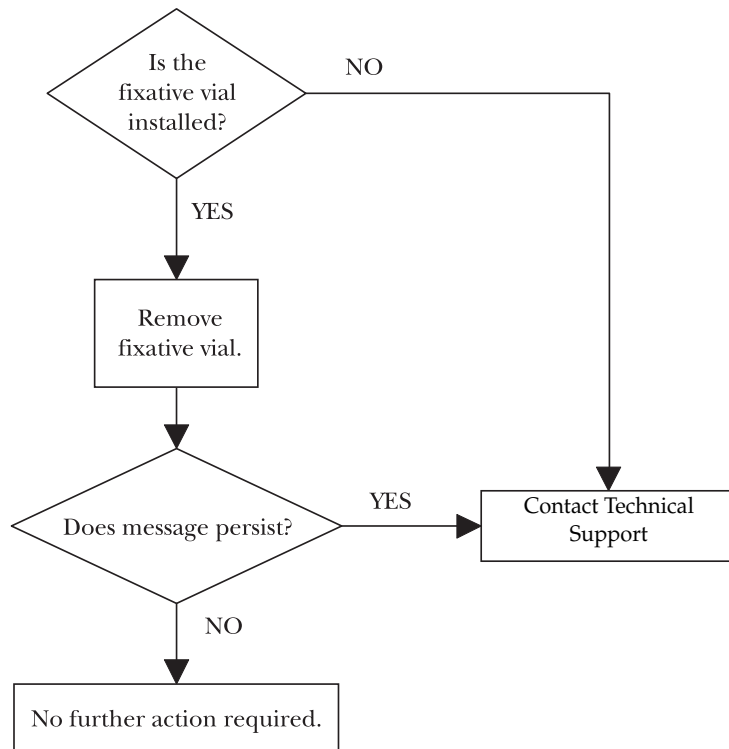



Remove Slide

Reason for Message

This message appears when the instrument has completed processing a slide and the slide has not been ejected from the slide handler. This error generally occurs when another error condition has occurred which prevents the instrument from ejecting the slide. The processor will pause until the operator corrects the situation.

Possible Causes

- Error recovery requires slide removal.

Procedure

See flowchart on next page.

Notes

To remove a slide, push down on the front edge of the slide. While holding the slide by this edge, gently pull the slide out of the instrument.

If the slide is installed and it has cells on it, the cells on the slide are likely to be air-dried.

Remove Slide

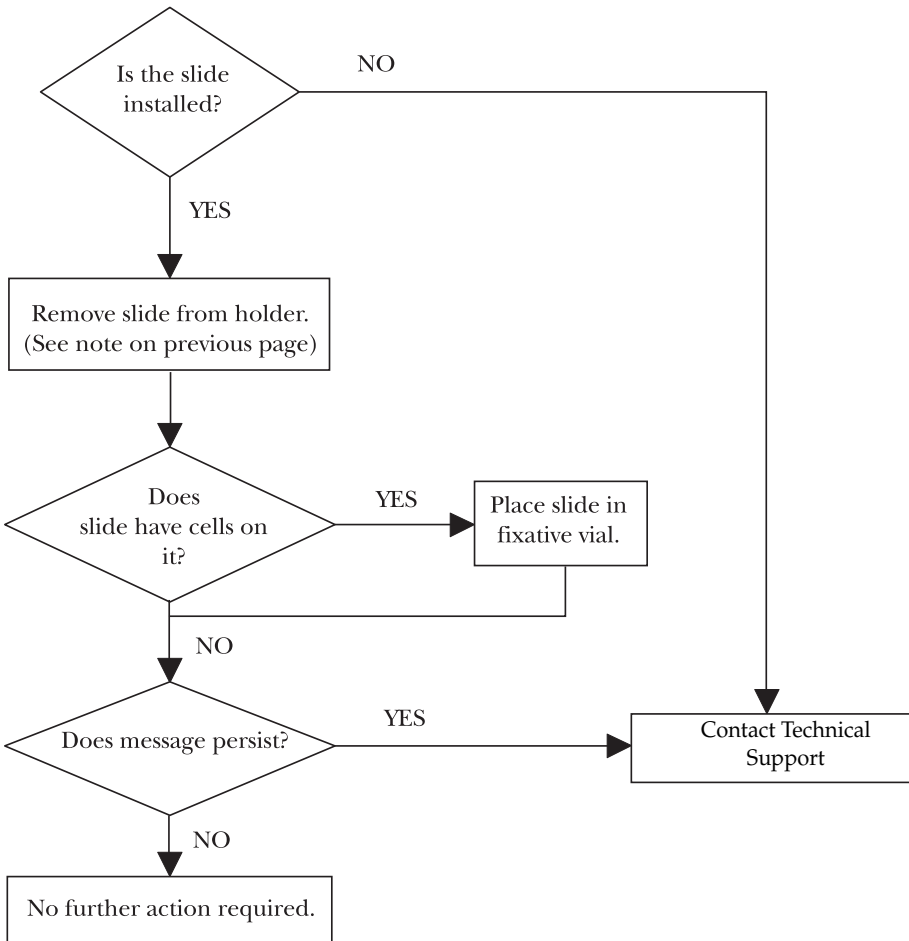



Remove Fix Bath to Continue Processing

Reason for Message

This message is designed to warn the operator that a fixative vial was in the fix vial holder when the instrument power was turned on. The processor will pause until the operator corrects the situation.

Possible Causes

- System powered on with fixative vial installed.

Procedure

See flowchart on next page.

Remove Fix Bath to Continue Processing

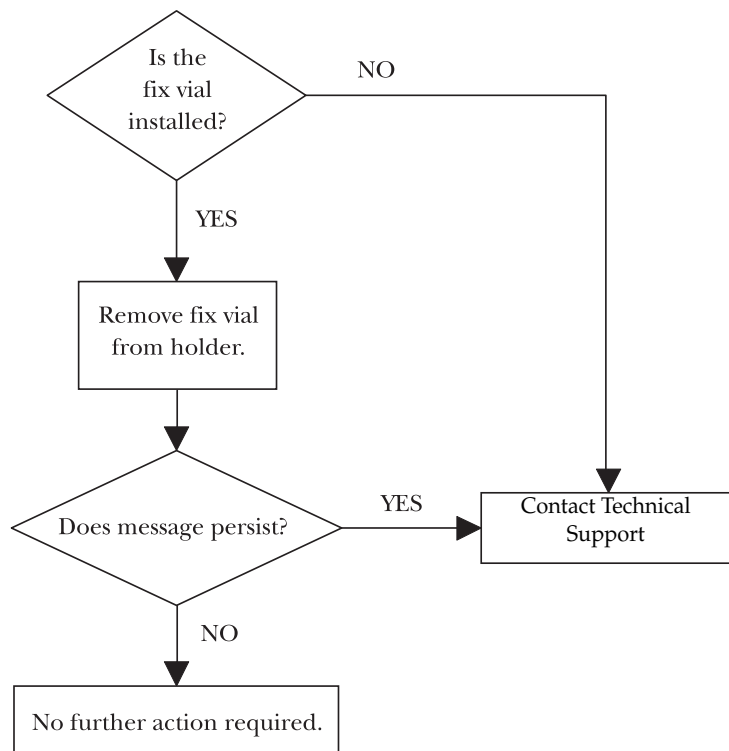



Remove Slide to Continue Processing

Reason for Message

This message is designed to ensure that cell transfer occurs only once per slide. The slide from a previous run has not been ejected or a slide was present in the slide handler when the instrument power was turned on. The processor will pause until the operator corrects the situation.

Possible Causes

- System powered on with slide installed.

Procedure

See flowchart on next page.

Notes

To remove a slide, push down on the front edge of the slide. While holding the slide by this edge, gently pull the slide out of the instrument.

If the slide is installed and it has cells on it, the cells on the slide are likely to be air-dried.

Remove Slide to Continue Processing

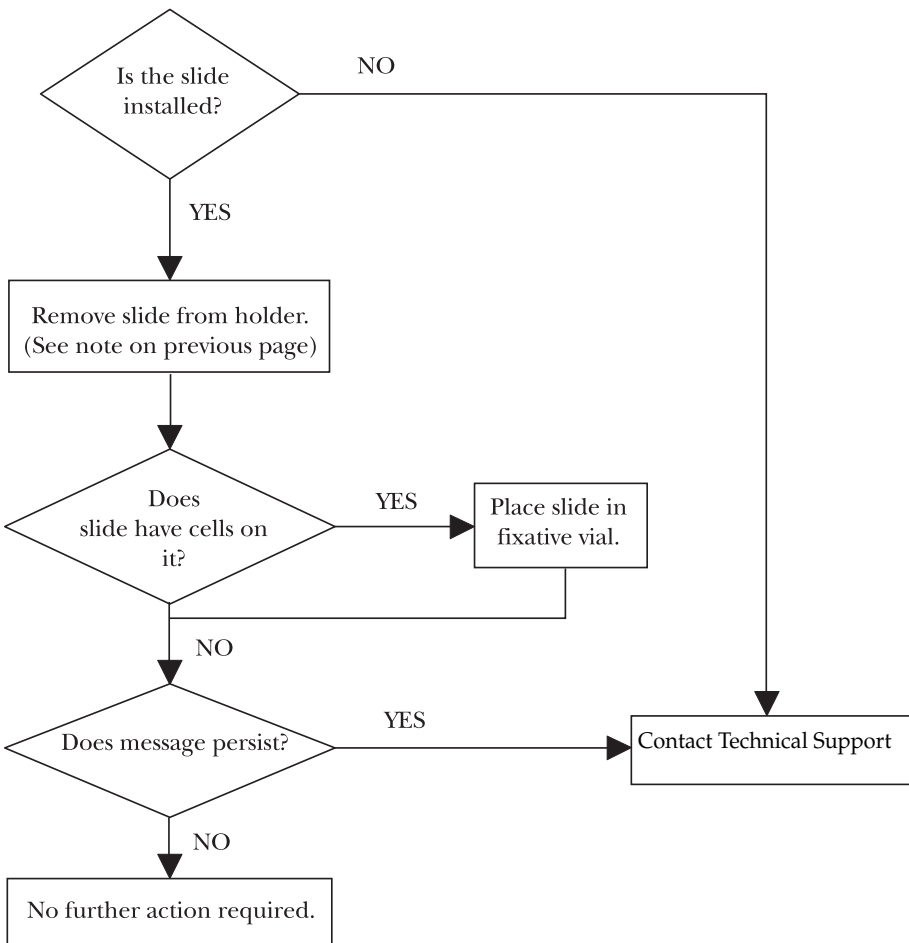



INSTRUMENT TROUBLESHOOTING

Sample Is Dilute

This message is displayed when most of the sample has been aspirated through the filter membrane, but the percentage of filter coverage has not reached the target coverage. This message is only a warning; the instrument continues to make a slide from the sample. Upon completion of the sequence, the instrument emits an audible alert until the operator presses the ENTER key. The slide should be stained and screened.

Reason for Message

There is a possibility of low concentration of cells in the sample.

Procedure

See flowchart on next page.

Sample Is Dilute

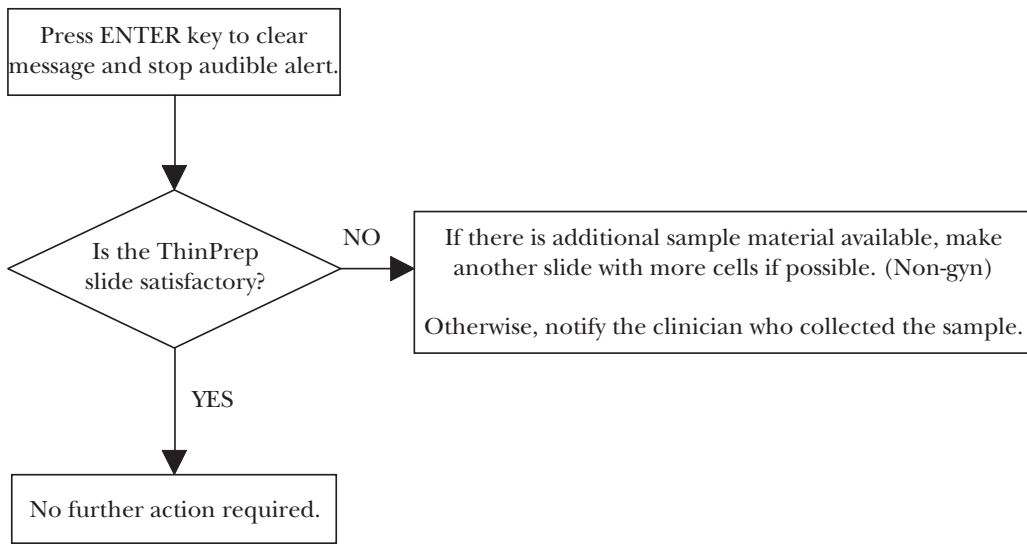



Evacuation Failure. Check Filter

Reason for Message

This message appears when the instrument detects a failure to completely evacuate filtrate from the Filter after cell collection is complete.

Possible Causes

- Waste bottle cap is not secure.
- Waste filter is wet.
- System hardware malfunction.
- Waste tubing is disconnected or obstructed at any point.
- Damaged ThinPrep Pap Test Filter.

Procedure

See flowchart on next page.

Notes

Check the waste bottle daily prior to beginning slide processing. Make sure that the fluid level does not exceed the “Max” mark on the waste bottle label.

If the waste bottle is overfilled, it may be necessary to remove the waste fitting with the waste filter from the rear of the instrument to allow the fluid to drain from the waste filter. Reattach the fitting and attempt to run a blank on the processor. If the error persists, replace the waste tubing, or waste filter, as described in “WASTE TUBING REPLACEMENT” on page 7.11.

Evacuation Failure. Check Filter

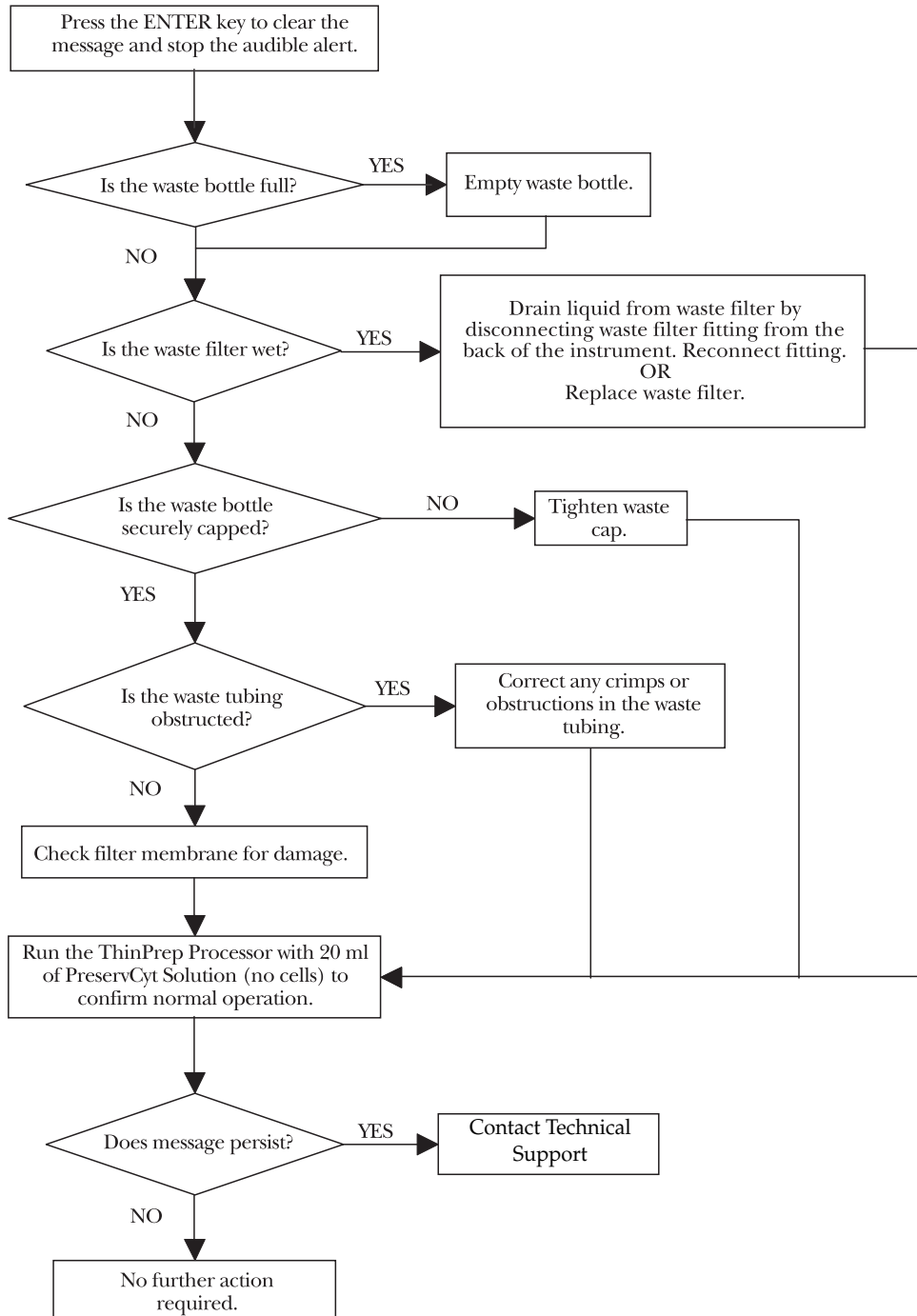



Filter Already Wet

Reason for Message

This message appears when the instrument cannot detect airflow throughout the ThinPrep Pap Test Filter prior to contact with the fluid. This is done to ensure that a previously used filter will not contaminate another sample.

Possible Causes

- Wet ThinPrep Pap Test Filter.
- Obstructed ThinPrep Pap Test Filter membrane.
- System hardware malfunction.

Procedure

See flowchart on next page.

Filter Already Wet

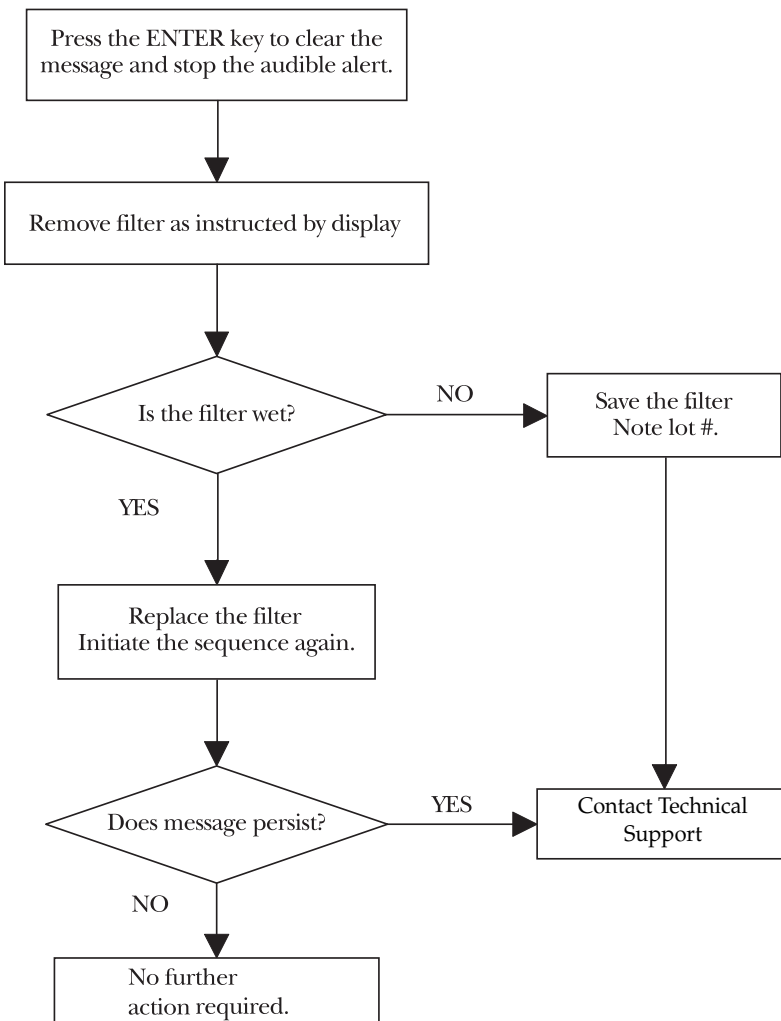



No Fluid Detected. Check Filter and Vial

Reason for Message

This message appears when the instrument cannot sense the appropriate liquid level in the PreservCyt® Sample vial.

Possible Causes

- PreservCyt Sample vial missing.
- Fluid in PreservCyt Sample vial too low.
- ThinPrep Pap Test Filter not installed.
- Large hole in ThinPrep Pap Test Filter membrane.
- Obstruction preventing cap seal from seating properly.
- Damaged cap seal O-ring.
- Pinched or obstructed pneumatic tubing.
- System hardware malfunction.

Procedure

See flowchart on next page.

No Fluid Detected. Check Filter and Vial

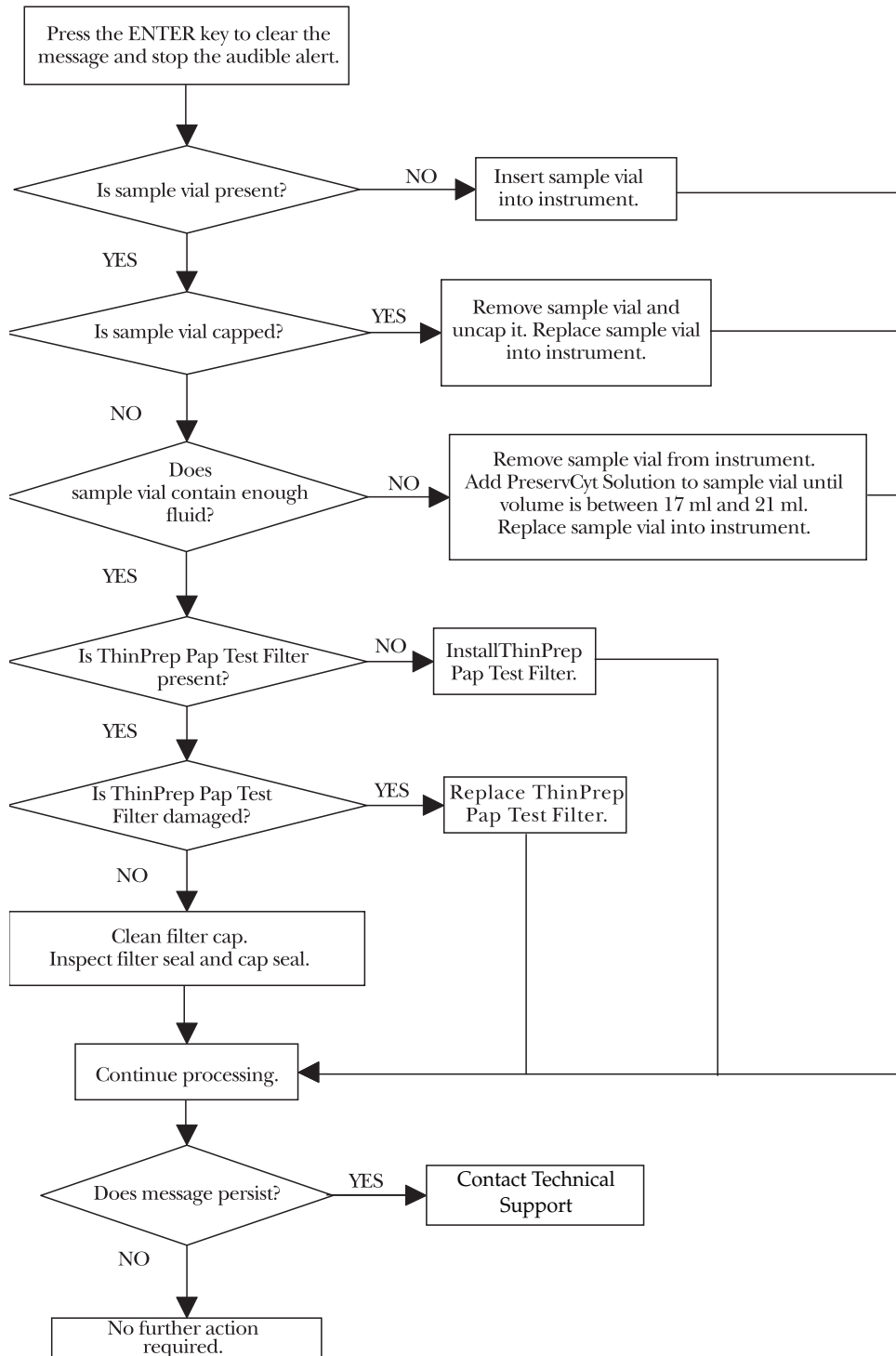



INSTRUMENT TROUBLESHOOTING

Sample Too Dense. Dilute 20:1 (for Non-Gyn only)

This message is displayed when the sample is too dense for the instrument to make a satisfactory slide. This will halt processing and no slide will be made. This message is followed by an audible alert until the operator presses the ENTER key.

Reason for Message

There is a possibility of high concentration of material in the sample vial.

Procedure

See flowchart on next page.

Sample Too Dense. Dilute 20:1 (for Non-Gyn only)

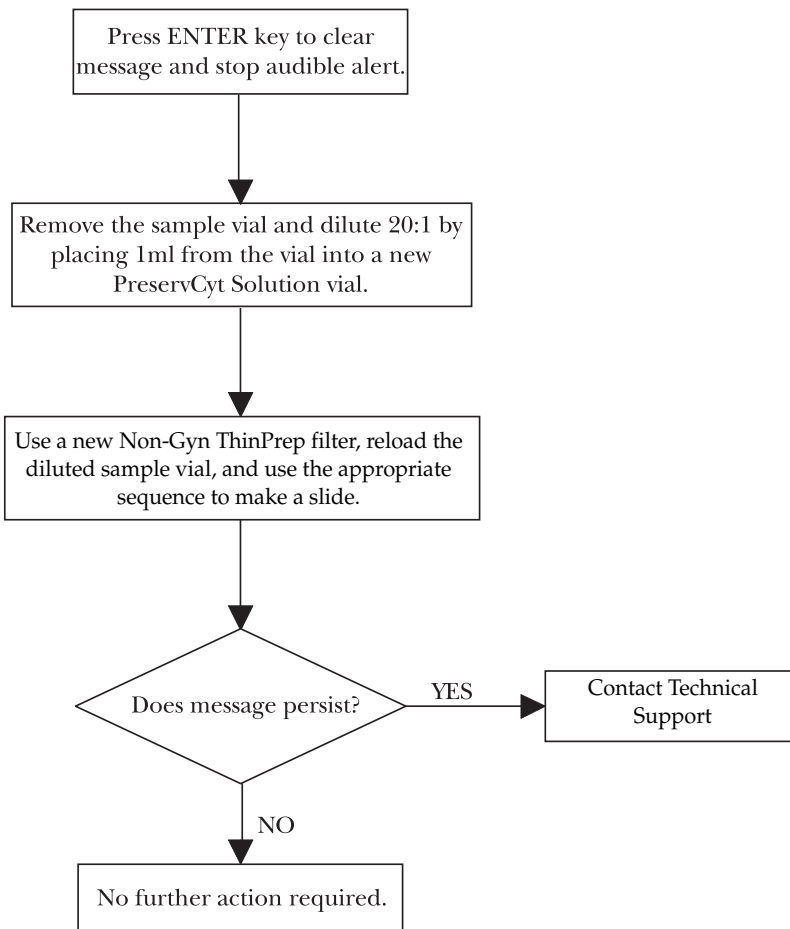



Vial Too Full. 21mL Max. Allowed

Reason for Message

This message appears when the instrument detects the fluid level of the PreservCyt Sample vial too early.

Possible Causes

- Volume of PreservCyt Sample vial is greater than 21ml.
- System hardware malfunction.

Procedure

See flowchart on next page.

If it is necessary to reduce the sample vial volume to be between 17ml and 21ml, save any excess fluid in an appropriate container.

Vial Too Full. 21mL Max. Allowed

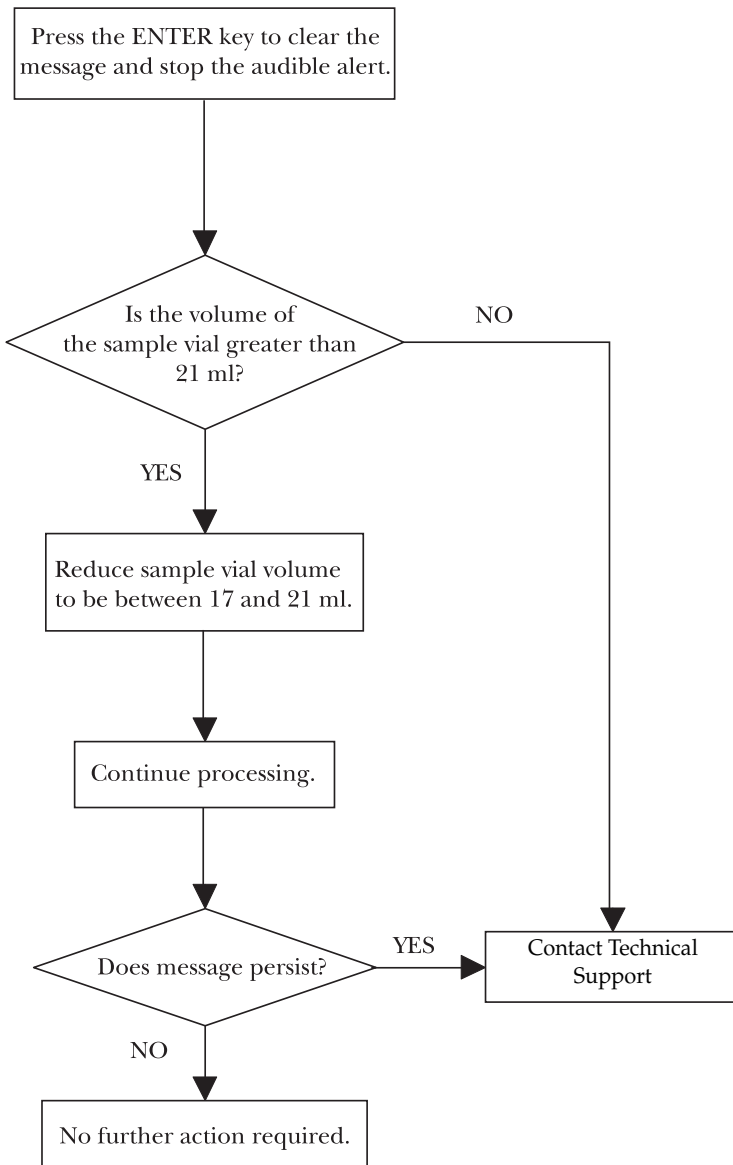



Waste System Failure

Reason for Message

This message appears when the instrument fails to detect its target negative pressure in the waste bottle during idle mode or at the start of a sequence.

Possible Causes

- Waste bottle cap is not secure
- Waste fittings are disconnected from back of instrument
- Waste tubing is disconnected or obstructed at any point
- System hardware malfunction
- Waste filter is wet

Waste System Failure

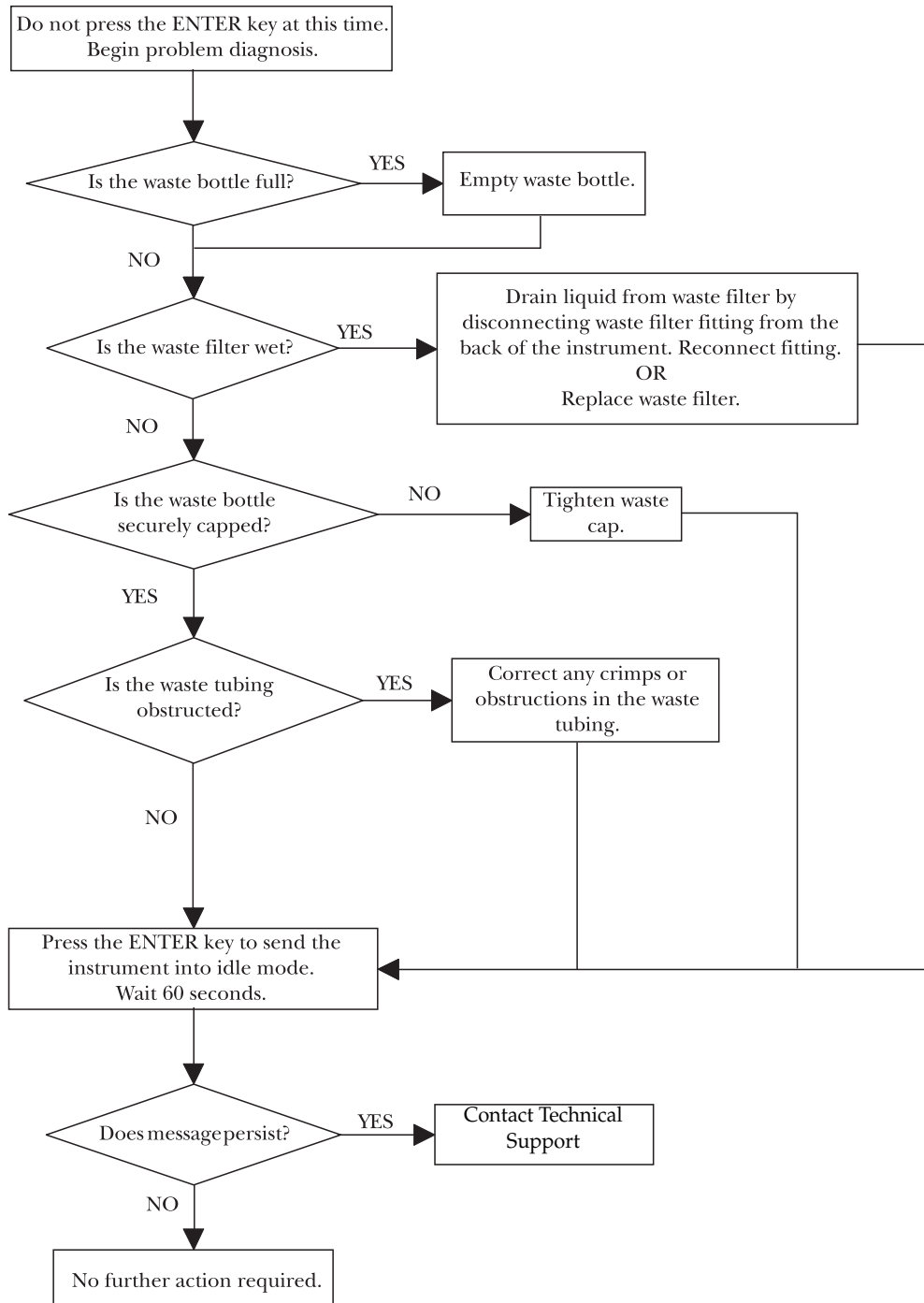



Door Open While Processing Sample

Reason for Message

This message appears when the instrument detects that the door of the instrument was opened during a sequence. The instrument will automatically abort the sequence and perform error recovery.

Possible Causes

- Door opened during sequence
- System hardware malfunction



Press ENTER with Door Closed to Retry Initialization. System Uninitialized

Reason for Message

This message appears when the instrument detects that the door of the instrument was open during start-up of the instrument. The operator must close the door and press ENTER to retry system initialization.

Possible Causes

- Door opened during instrument start-up
- System hardware malfunction



Stop Key Pressed

Reason for Message

This message appears when the user presses the STOP key during a sequence. The instrument will automatically abort the sequence and perform error recovery.

Possible Causes

- STOP key pressed during a sequence

**SECTION
D****ERROR HISTORY**

Operating errors and operator errors are logged numerically in the Error History as follows:

Error Text	Error
Vial too full. 21 ml max. allowed	3
Filter already wet	4
No fluid detected	5
Evacuation failure. Check filter	6
Waste system failure	18
DOOR OPEN WHILE PROCESSING SAMPLE	20
Sample too dense. Dilute 20:1	21
STOP KEY PRESSED	23
Press ENTER with door closed to retry initialization. System uninitialized	83



INSTRUMENT TROUBLESHOOTING

This page intentionally left blank.

Chapter Seven

Maintenance

SECTION
A

INTRODUCTION

This chapter describes routine maintenance procedures for the ThinPrep® 2000 Processor.

This chapter includes the following sections:

- SECTION B:** Emptying Waste Bottle
- SECTION C:** Filter Cap Cleaning
- SECTION D:** Filter Cap O-ring Lubrication
- SECTION E:** Filter Seal O-ring Replacement
- SECTION F:** Door Cleaning
- SECTION G:** Cap Seal Cleaning
- SECTION H:** General Cleaning
- SECTION I:** Waste Tubing Replacement
- SECTION J:** Waste Filter Replacement
- SECTION K:** Emptying and Cleaning the Catch Tray
- SECTION L:** Moving the ThinPrep 2000 Processor
- SECTION M:** Maintenance Schedule

Note: Any procedure not described in this section requires specially trained personnel. Contact Hologic Technical Support for more information.

SECTION B EMPTYING WASTE BOTTLE

Check the waste bottle on a daily basis and empty it before the fluid level reaches the “MAX” marking on the bottle.

1. **Disable the waste system** —
 - From the Main Menu, select the down arrow key to display the second Main Menu screen.
 - Select option 7, Maintenance.
 - Select option 2, Waste System.
 - Remove all the disposables from instrument and press ENTER.
 - Wait for the system to vent the waste bottle and display the “ENTER when finished.” message.
2. **Cap removal** — Open the waste bottle cap by rotating the waste cap while holding the bottle in place to avoid tangling the waste tubing.

See Figure 7-1.

Do not remove the length of tubing connected to the inside of cap.

Figure 7-1 Opening/Closing the Waste Bottle

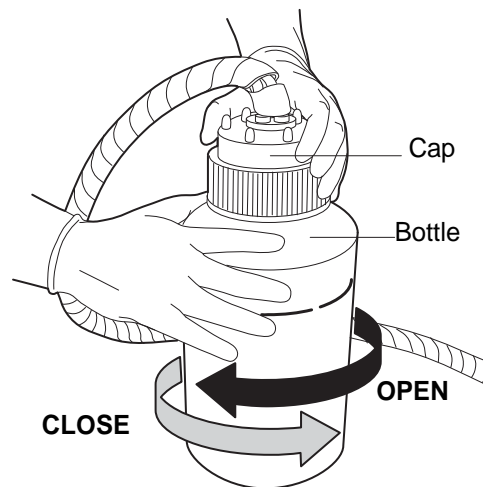

3. **Transport cover** — An extra plain cap without tubing fittings is included with the ThinPrep Processor for transporting the waste bottle. Place this cover on the waste bottle when transporting to the disposal area.
4. **Waste disposal** — Dispose of all solvents as hazardous waste. Follow local, state, provincial and federal or county guidelines. As with all laboratory procedures, universal precautions should be followed. PreservCyt Solution contains methanol. See Chapter 3, “PreservCyt Solution”, for more information about PreservCyt Solution.
5. **O-ring seal** — Inspect the O-ring seal located on the inside of the waste cap assembly for any debris. If required, clean the seal with de-ionized, or distilled, water using a lint-free wipe and apply a thin layer of lubricant grease to the O-ring from the tube included with the ThinPrep 2000 Processor.
6. **Cap replacement** — Replace the waste cap onto the bottle being careful not to pinch the tubing located on the inside of the waste cap assembly.
7. **Inspection** — Make sure the waste cap is firmly tightened. The waste cap must be tight for proper waste bottle operation.

Check that the waste tubing between the waste bottle assembly and the ThinPrep Processor is not pinched or twisted.

Check that the quick disconnect fittings located at the rear of the ThinPrep Processor are secure. See Chapter 2, “ThinPrep 2000 Installation”, for details.

8. **Completion** — Press the ENTER key when this operation is complete. The system will be available for sample processing when the display returns to the Main Menu.

SECTION C FILTER CAP CLEANING

Clean the filter cap daily. It is important that the top surface of the filter cap and the cap seal O-ring are free of debris for proper operation of the system.

Wipe the entire filter cap with a lint-free wipe dampened with de-ionized or distilled water to remove deposits. Dry the filter cap after cleaning.

Note: Handle the filter cap gently. Do not hit it against hard surfaces.

Figure 7-2 Filter cap

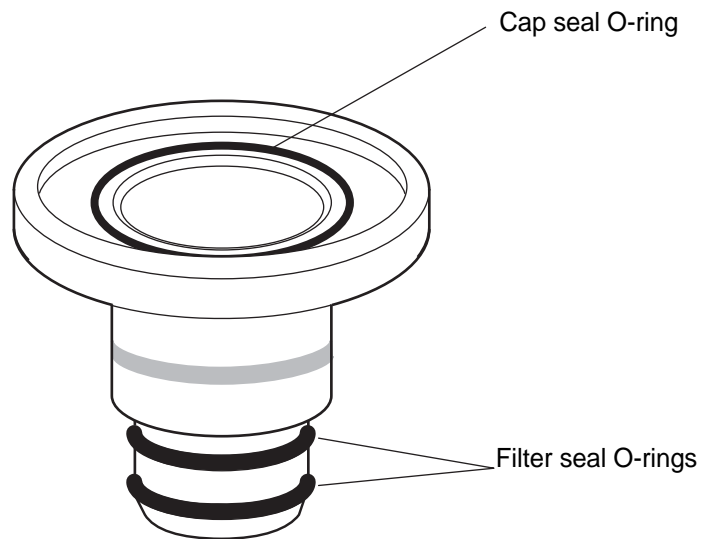

SECTION
D**FILTER CAP O-RING LUBRICATION**

Inspect the filter seal O-rings located at the base of the filter cap for dryness. An indication of dryness is difficulty inserting a ThinPrep Pap Test Filter onto the filter cap.

Inspect the cap seal O-ring located at the top of the filter cap for dryness. If the cap seal O-ring is damaged, replace the entire filter cap.

Perform the following procedure weekly on the cap seal O-ring and whenever any of the filter seal O-rings are dry.

1. Using the tube of high vacuum silicone grease included with the ThinPrep 2000 Processor, apply a small amount of grease to each of the three O-rings as shown in Figure 7-3.
2. Using a gloved finger, spread the grease until a thin layer of grease covers each of the O-rings. Remove any excess grease from the three O-rings with a lint-free wipe.

Figure 7-3 Filter cap O-ring lubrication

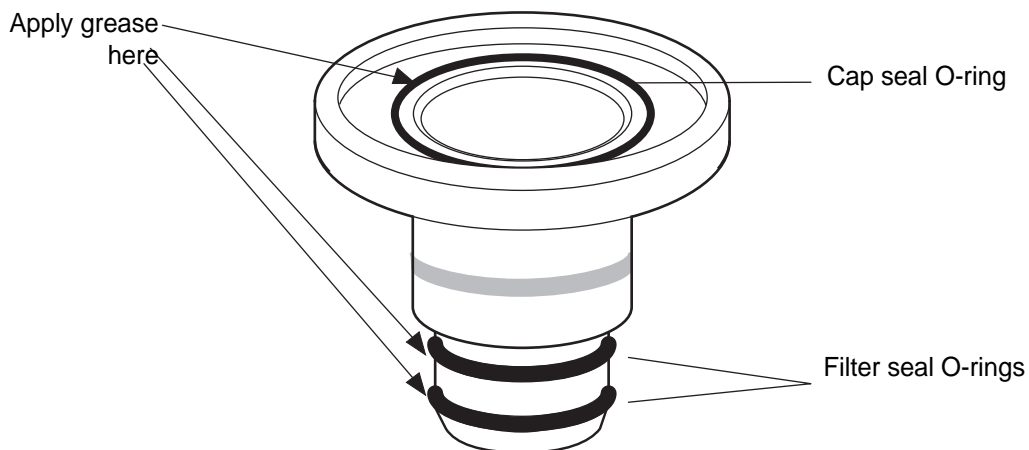

SECTION E FILTER SEAL O-RING REPLACEMENT

Inspect the filter seal O-rings located at the base of the filter cap for cracking or tearing. Perform the following procedure if the O-rings are cracked or torn.

If the cap seal O-ring is cracked or torn, replace the entire filter cap.

Caution: Do not attempt to remove the cap seal O-ring.

1. Using a plastic or wooden utensil (toothpick is ideal), lift filter seal O-ring out of groove then roll the O-ring off the edge of the filter cap base as in Figure 7-4.

Figure 7-4 Filter seal O-ring replacement

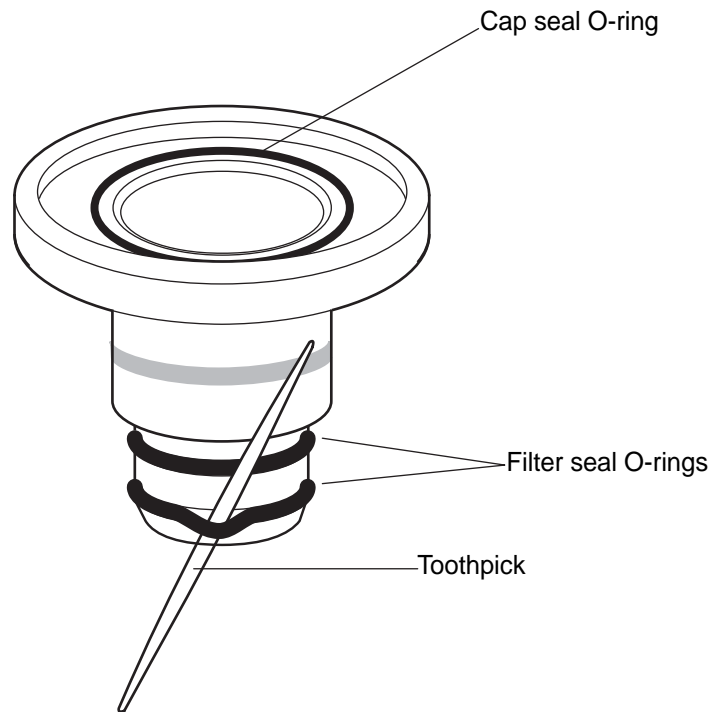

2. Roll the new O-ring over the edge of the filter cap base until it is seated in the appropriate groove.
3. Make sure that the new filter seal O-ring is seated properly and not twisted. Lubricate the new filter seal O-ring as described in Section D.

Note: Do not use the filter cap with only one filter seal O-ring installed. This may cause splashing during the dispersion phase and produce an insufficient seal for proper operation.

SECTION
F

DOOR CLEANING

The door of the ThinPrep 2000 Processor may become dirty over time. To clean the door, it is best to use a commercially available glass cleaner.

Cleaning the hinged door

For instruments with the hinged door, open the door and clean the inside surface of the window with a lint-free wipe. Close the door and clean the outside surface of the door's window with a lint-free wipe.

Cleaning the sliding door

For instruments with the sliding door, follow the instructions below.

1. It is necessary to open the door mechanism to clean the inside surface of the plastic. Slide the door open approximately three inches. With your left thumb, release the tab on the open edge of the door and push the back of the window out with your fingers. Refer to Figure 7-5.

Figure 7-5 Opening door for cleaning, instruments with a sliding door

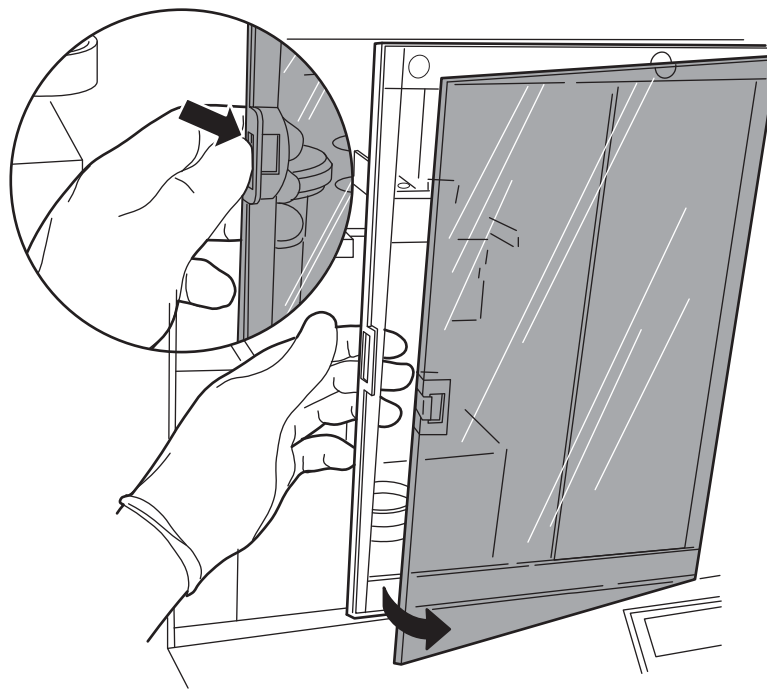

Release tab and push back of window out

2. Open the window to the right and clean the inside surface of the window with a lint-free wipe.



7 MAINTENANCE

3. Gently close the window until it snaps back into the door frame.
4. Clean the outside surface of the door's window with a lint-free wipe.
5. Close the door by sliding it to the left.

SECTION
G

CAP SEAL CLEANING

The cap seal is a stainless steel part that covers the top of the filter cap during sample processing. The cap seal has two tubing connections on its top side. Debris can accumulate and dry on the underside of the cap seal; therefore, periodic cleaning is required.

To clean the underside of the cap seal follow the instructions outlined below:

- From the Main Menu, select the down arrow key to display the second Main Menu screen.
- Select option 7, Maintenance.
- Select option 2, Waste System.
- Remove all the disposables from the instrument and press ENTER.
- Wait for the system to complete its movements and display the “ENTER when finished.” message.

This procedure inverts the rotating plate allowing a clear view of the underside of the cap seal.

Dampen a lint-free wipe with de-ionized water. Wring the wipe so that it is *damp*, not dripping. Clean any dust, dried salts, etc., from the underside of the cap seal. Upon completion of the cleaning, press the ENTER key to return to the Main Menu.

This procedure should be performed on a daily basis.

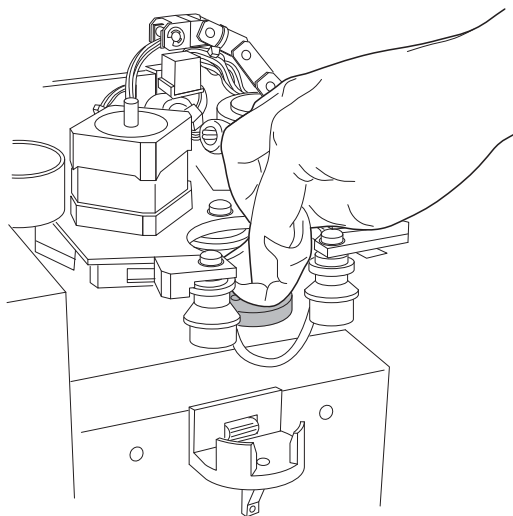

7 MAINTENANCE

SECTION H GENERAL CLEANING

Use a lint-free wipe, dampened with de-ionized water, to clean any dust from the filter cap bobbins, slide holder, and cabinet exterior. Turn off the power to the instrument before cleaning any areas except for the cap seal and below the sample holder.

Occasionally drops may fall off of a filter as it rotates for evacuation. These drops fall on the base liner (absorbent pad) below the sample holder. This area also requires periodic cleaning. To gain access to this area, execute the Waste System sequence as described in "CAP SEAL CLEANING" on page 7.9.

In general, be sure to clean up spills when they occur. Use a lint-free wipe to absorb any spills and then wipe the area of the spill with a lint-free wipe dampened with de-ionized water.

SECTION

|

WASTE TUBING REPLACEMENT

The tubing located inside the waste control box must be replaced every six months. The waste control box is accessible through the access panel located on the left side of the ThinPrep 2000 Processor.

1. Disable the waste system —
 - From the Main Menu, select the down arrow key to display the second Main Menu screen.
 - Select option 7, Maintenance.
 - Select option 2, Waste System.
 - Remove all the disposables from the instrument and press ENTER.
 - Wait for the system to complete its movements and display the “ENTER when finished.” message.
2. There are two styles of access panels. If the access panel on your instrument is a hinged door, open the door.

If the access panel on your instrument uses screws, use the #1 tip (small) Phillips head screwdriver provided to loosen the two Phillips head screws that secure the access panel shown in Figure 7-6. Only a 1/4 turn counterclockwise is required to loosen these screws. Do not attempt to unscrew them completely. Remove the access panel and set it aside.

Figure 7-6 Opening the access panel

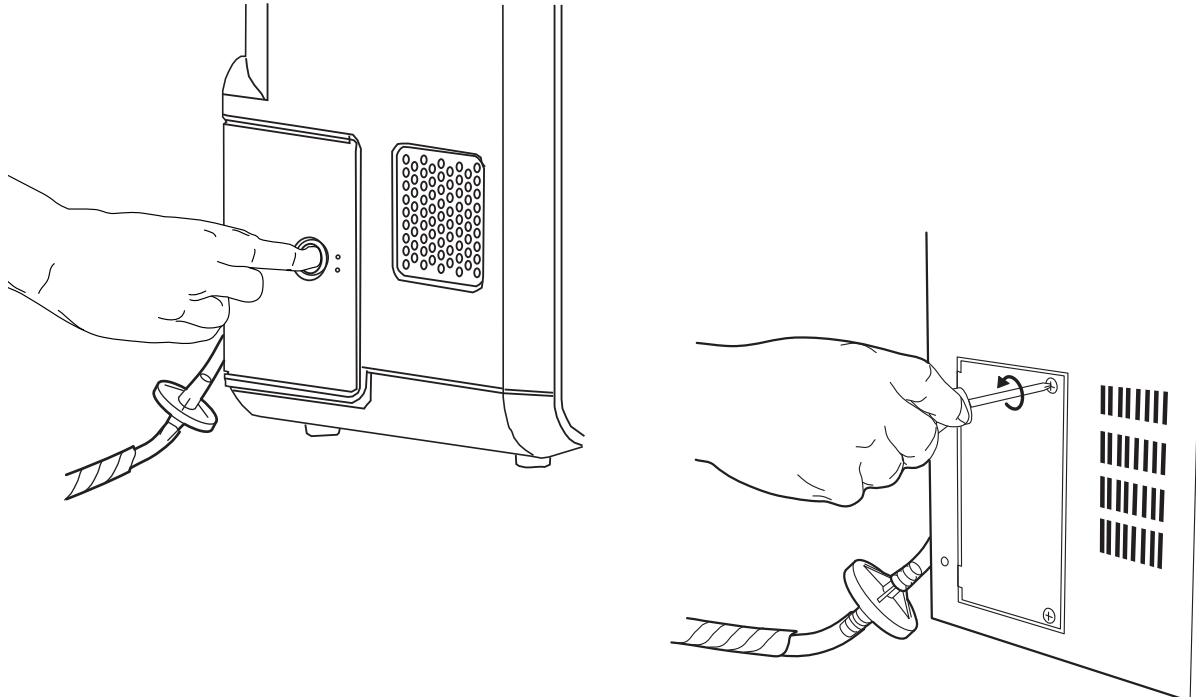

3. Locate the pieces of flexible tubing shown in Figure 7-7.

Figure 7-7

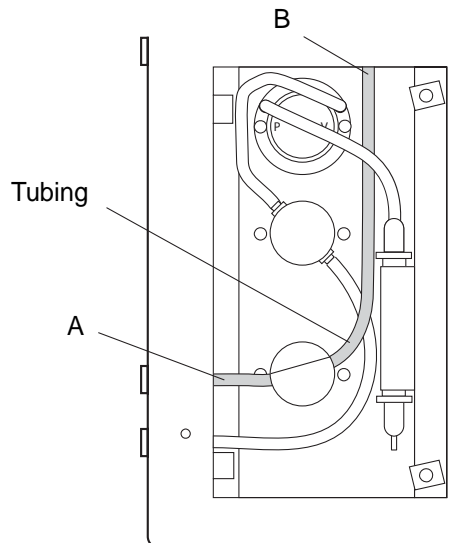

4. Detach tubing from points A and B shown in Figure 7-8.

Figure 7-8

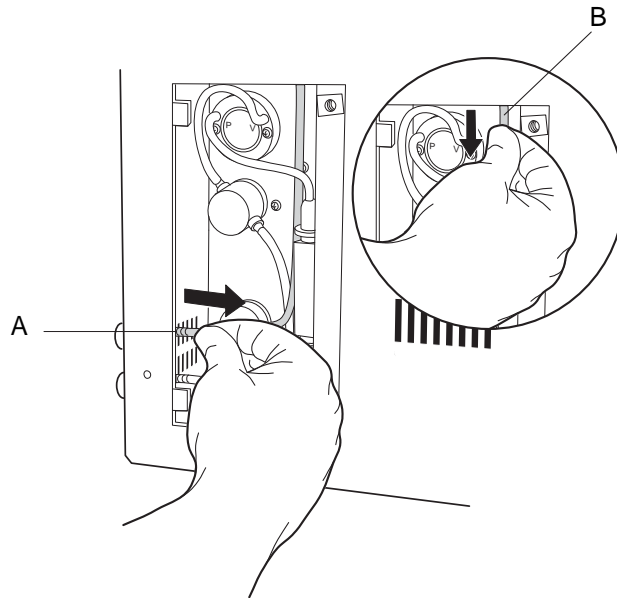

5. Holding the tubing on each side of the valve, slide it out of the valve in the direction shown in Figure 7-9. Discard tubing.

Figure 7-9

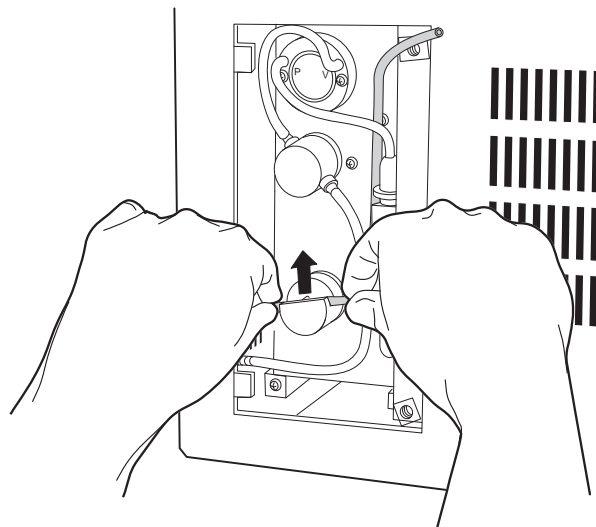

6. Locate the replacement tubing. Slide the tubing into the valve using a back and forth motion while pushing the tubing into the valve. See Figure 7-10. Make sure tubing is fully inserted and not twisted.

Figure 7-10

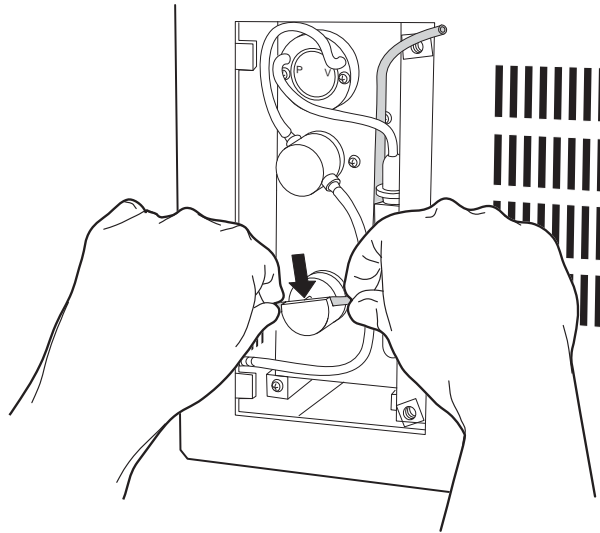

7. Connect the replacement tubing to points A and B shown in Figure 7-11. Make sure tubing fully covers each fitting.

Figure 7-11

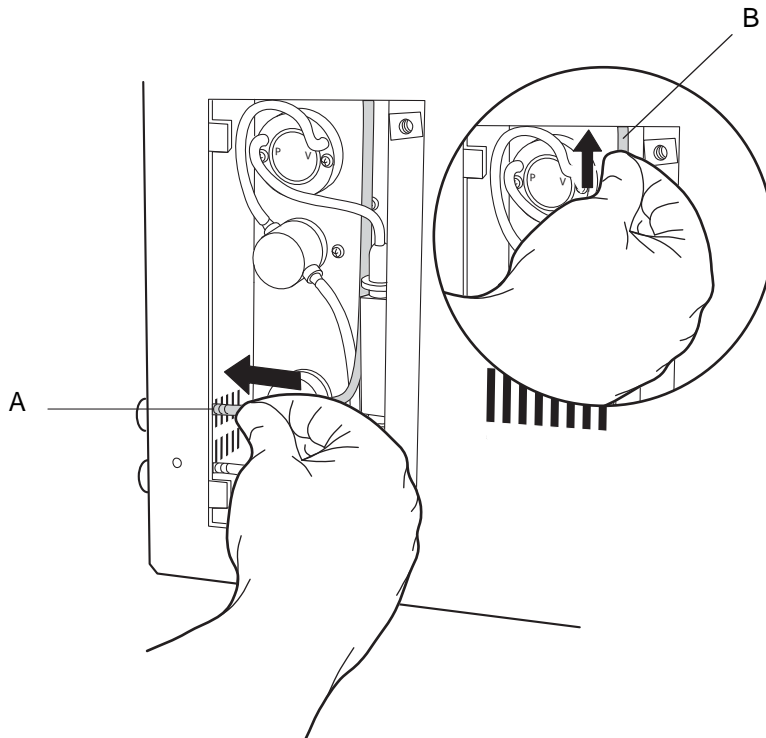

8. Close the access panel, or replace it and secure with the two Phillips head screws. Turn the two screws clockwise to tighten.
9. Press the ENTER key. The waste system maintenance will automatically reset and return the instrument to the Main Menu.
10. To test the new tubing installation, run a blank PreservCyt Solution sample vial (no cells) using the “Run Blank Sample” procedure outlined in Chapter 2, “ThinPrep 2000 Installation”, of this manual.

Note: Additional replacement tubing is available from Hologic.

SECTION J WASTE FILTER REPLACEMENT

If the waste bottle is allowed to overflow, the waste filter may become wet. The ThinPrep 2000 Processor will detect a problem and report an error message.

1. Turn off the instrument.
2. Attempt to salvage the waste filter by draining the fluid from the waste filter. In the back of the instrument, detach the bottom connector (yellow) which has the waste filter in line. The liquid in the waste filter may adequately drain from the waste filter at this time. If it does not drain, force the liquid off of the filter by placing a syringe, or other clean air source, into the attached connector. Repeat until the filter is no longer visibly wet. Reattach the connector, turn on the power, and attempt to run a blank (PreservCyt Solution vial with no cells) on the system to test its operation.
3. If the processor continues to detect a problem, turn off the power and detach all the waste connectors from the rear of the instrument.
4. Remove the tubing and connector attached to the top of the waste filter by pulling on the tubing. It may be necessary to cut the tubing. Refer to Figure 7-12.

Figure 7-12 Waste filter replacement

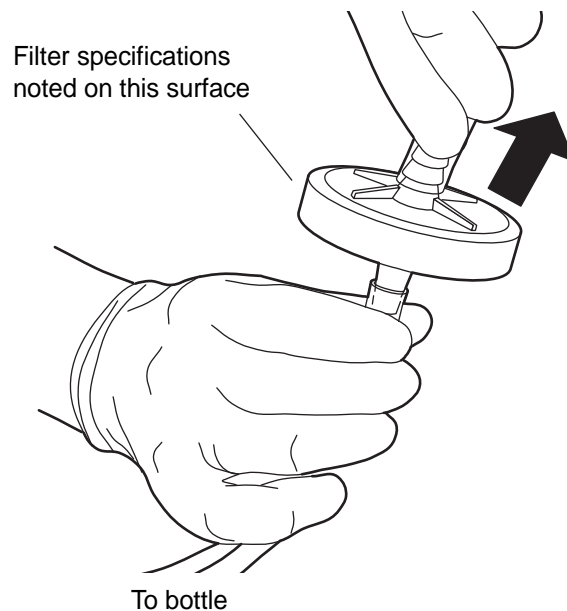

5. Remove the waste filter from the lower piece of tubing. It may be necessary to cut the tubing.
6. Attach the new waste filter to the lower piece of tubing.

Make sure the new waste filter is correctly oriented. The filter specification notations on the waste filter must be on the connector side of the filter, not the waste bottle side.

7. Attach the tubing to the top of the new waste filter.
8. Reattach all the waste connectors to the rear of the instrument. Refer to Chapter 2, "ThinPrep 2000 Installation", for more information.
9. Turn on instrument power.
10. Run a blank (PreservCyt Solution vial with no cells) on the processor to test the operation of the instrument.



SECTION
K

EMPTYING AND CLEANING THE CATCH TRAY

1. If the ThinPrep 2000 Processor is equipped with a catch tray, on a frequent basis observe how much liquid is collected in the catch tray. When the level is near the first indentation from the bottom, empty the tray.
2. From the Main Menu on the keypad, Select option 7 (Maintenance) Key. From the Maintenance Menu select option 2 (Waste System) and press Enter. This step will raise the sample holder out of the way and allow you to remove the tray from the instrument.
3. Grasping the handle, lift the tray straight up and out of the cabinet.
4. Debris such as brushes, caps or filters may have collected in the tray in addition to PreservCyt Solution. Inspect the contents of the tray upon removal. Discard the contents according to your laboratory guidelines.
5. The catch tray may be cleaned with soap and water or with a 10% bleach mixture. Make sure the tray is completely rinsed and dried before returning it to the instrument.

Re-Insert the Catch Tray

1. Place the catch tray into the cabinet. The handle should be near the front of the instrument. (The catch tray is shown in white for clarity. The catch tray is black.)
2. The catch tray has molded indents on the bottom surface that engage with two large screw heads on the bottom of the cabinet. You will feel the screws are inserted into the indents when the tray is correctly in place. Verify that the catch tray is secure by gently pressing on the inside of the tray towards the front of the instrument. The tray should not be loose.

Figure 7-13 Place the Catch Tray into the cabinet. Fit screws into the tray indents.



The ThinPrep 2000 Processor is ready for use.

Note: If the sample holder hits the catch tray during operation and causes a system error, reseal the tray to make sure it is fully inserted.

SECTION
L**MOVING THE THINPREP® 2000 PROCESSOR**

If it becomes necessary to change the location of your ThinPrep 2000 Processor, be sure to follow one of the two procedures described below.

Unit moved within building:

1. Turn off power.
2. Disconnect power cord from the electrical outlet and instrument.
3. Empty the waste bottle.
4. Disconnect waste bottle from the instrument at connector fittings.
5. With the help of another person, hold the instrument level and carefully place the ThinPrep Processor onto the flat surface of a cart. Roll the unit to its new location.
6. With the help of another person, lift the unit from the cart and place it onto its new surface.
7. Reconnect the power cord and waste bottle.
8. Run a blank (PreservCyt Solution vial with no cells). Refer to the instructions in "RUN A BLANK SAMPLE" on page 2.11.

Unit shipped to new location:

1. Turn off power.
2. Remove Program Memory Card by pushing in the black button.
3. Disconnect power cord from the electrical outlet and instrument.
4. Empty the waste bottle.
5. Disconnect waste bottle from the instrument at connector fittings.
6. Reattach internal securements. Refer to "CONNECTING THE WASTE BOTTLE" on page 2.6.
7. With the help of another person, hold the instrument level and carefully place the ThinPrep 2000 Processor into its box. Place the instrument's accessories in the box. Seal the box and ship the unit.
8. When the unit arrives at its destination, follow the instructions in Chapter 2, "ThinPrep 2000 Installation", for unpacking the instrument.
9. Run a blank (PreservCyt Solution vial with no cells).
10. Perform Pneumatic Test, refer to page 5A.25.



SECTION
M

MAINTENANCE SCHEDULE

Table 7.1: Maintenance Schedule

Procedure	Frequency
Waste Bottle Emptying	As needed
Filter Cap Cleaning	Daily
Pneumatic System Test (see Chapter 5A)	Weekly
Cap Seal O-ring Lubrication	Weekly (or as needed)
Filter Seal O-ring Lubrication	As needed
Filter Seal O-ring Replacement	As needed
Door Cleaning	As needed
General Cleaning	Monthly
Waste Tubing Replacement (in pinch valve)	Six months
Waste Filter Replacement	As needed
Cap Seal Cleaning	Daily
Empty and Clean Catch Tray (if present)	As needed



ThinPrep 2000 Processor
Maintenance Schedule for the Month: _____

Reference: Frequency:	page 7.2 Daily/Weekly	page 7.4 DAILY	page 5A.25 WEEKLY	page 7.5 WEEKLY	page 7.5 DAILY	page 7.9 DAILY	page 7.7 WEEKLY	page 7.10 MONTHLY
DATE	EMPTY WASTE BOTTLE	CLEAN FILTER CAP	PNEUMATIC TEST	CAP SEAL O-RING LUBE	FILTER SEAL O-RING LUBE	CLEAN CAP SEAL	DOOR CLEANING	GENERAL CLEANING
1								
2								
3								
4								
5								
6								
7								
8								
9								
10								
11								
12								
13								
14								
15								
16								
17								
18								
19								
20								
21								
22								
23								
24								
25								
26								
27								
28								
29								
30								
31								

Note: This page is for photocopy purposes.



7 MAINTENANCE

This page intentionally left blank.

Chapter Eight

Fixation, Staining, and Coverslipping

SECTION

A

INTRODUCTION

Following is a description of these *recommended guidelines* for fixation procedures, staining protocols, and coverslipping methods.

Note: There is wide variation among laboratories in fixation, staining, and coverslipping methods employed for cytologic specimens. The thin layer characteristics of ThinPrep[®] Processor prepared slides allow precise assessment of the effects of these differences in protocols and allows the laboratory personnel to optimize their methods by following the general guidelines provided in this section. These guidelines are recommendations and should not be considered absolute requirements.



FIXATION, STAINING, AND COVERSIPPING

SECTION B

FIXATION

The ThinPrep 2000 Processor deposits completed slides into a fixative vial that contains 95% reagent alcohol or 95% ethyl alcohol. Use the following procedure to fix ThinPrep microscope slide preparations.

1. Remove each slide after it is deposited into the fixative vial in the ThinPrep 2000 Processor.
2. Place the slide in a multi-slide holder and place the slide holder into a fixative bath containing 95% reagent alcohol or 95% ethyl alcohol. In order to minimize exposure of ThinPrep microscope slides to air:
 - When transferring ThinPrep microscope slides from the fixative vial to the multi-slide fixative container, care should be taken to perform this operation quickly.
 - If ThinPrep microscope slides are being transferred to a staining rack, care should be taken that ThinPrep slides are continuously immersed in fixative.
3. **Gyn slides:** ThinPrep microscope slides should be fixed for at least 10 minutes prior to staining.

Non-Gyn slides: ThinPrep microscope slides should be fixed for at least 10 minutes prior to staining or application of fixative spray.

For Gyn slides intended for use with the ThinPrep® Imaging System: If the slides must be shipped to another site prior to staining, CellFyx™ Solution fixative must be applied.

Note: No other spray fixative has been validated for use with the ThinPrep Imaging System. Contact Hologic Customer Service for ordering. See the instructions for use that come with the fixative solution.

SECTION
C

STAINING

General guidelines to consider when staining ThinPrep slides are:

- Staining times may be different and may require adjustment for ThinPrep slides compared to conventional preparations.
- The use of graded concentrations of alcohol in the staining process will minimize cell distortion and possible cell shedding.
- The use of mild bluing solutions and dilute acid baths will optimize nuclear staining and minimize possible cell shedding.

Staining Protocol:

A recommended staining protocol for ThinPrep slides is attached. This protocol incorporates the general staining guidelines stated above and the following specific recommendations:

1. If slides have been spray fixed, remove the spray fixative by soaking in a standard laboratory fixative for at least 10 minutes.
2. Stain the ThinPrep slides with standard modified Papanicolaou stains according to the manufacturer's routine procedures adjusting to the general guidelines for ThinPrep slide staining stated above.
3. Standard staining times for ThinPrep slides may be different from conventional slides, and it may be necessary to increase or decrease these times. It is recommended that staining times be optimized following laboratory standard operating procedures. These differences may necessitate staining ThinPrep and conventional slides separately.



FIXATION, STAINING, AND COVERSIPPING

4. Hologic recommends minimizing exposure of slides to strong acidic or strong basic solutions since this may result in possible cell shedding. Below are recommended maximum concentrations of some solutions:
 - Hydrochloric acid (HCl) 0.025%
 - Lithium Carbonate (bluing) baths 10mg per liter¹
 - Acetic acid 0.1%
 - Ammonium Hydroxide 0.1%
5. Avoid the use of strong salt solutions like Scotts Tap Water Substitute. Hologic recommends the use of a dilute Lithium Carbonate solution or Ammonium Hydroxide solution as the bluing solution.
6. During the hydration dehydration process, use graded concentrations e.g., 50%, 70% of alcohol. This lowers the potential of osmotic shock and possible cell shedding during staining.
7. Bath solution heights should be sufficient to completely cover the slides during the entire staining cycle to reduce the possibility of shedding cells.
8. Slides should be agitated for at least 10 dips in each bath.

1. Refer to Bales, CE. and Durfee, GR. *Cytologic Techniques* in Koss, L, ed. *Diagnostic Cytology and its Histopathologic Basis*. 3rd Edition. Philadelphia: JB Lippincott. Vol. II: pp 1187–1260 for details

Table 8.1: Hologic Staining Protocol

	Solution	Time
1.	70% Reagent Alcohol	1 minute with agitation
2.	50% Reagent Alcohol	1 minute with agitation
3.	Distilled H ₂ O (dH ₂ O)	1 minute with agitation
4.	Richard-Allan Hematoxylin I	30 seconds with agitation*
5.	Distilled H ₂ O (dH ₂ O))	15 seconds with agitation
6.	Distilled H ₂ O (dH ₂ O))	15 seconds with agitation
7.	Clarifier (0.025% glacial acetic acid)	30 seconds with agitation
8.	Distilled H ₂ O (dH ₂ O))	30 seconds with agitation
9.	Bluing Reagent (10mg LiCarb/1L)	30 seconds with agitation
10.	50% Reagent Alcohol	30 seconds with agitation
11.	95% Reagent Alcohol	30 seconds with agitation
12.	Richard-Allan Scientific™ Cyto-Stain™	1 minute with agitation
13.	95% Reagent Alcohol	30 seconds with agitation
14.	95% Reagent Alcohol	30 seconds with agitation
15.	100% Reagent Alcohol	30 seconds with agitation
16.	100% Reagent Alcohol	30 seconds with agitation
17.	100% Reagent Alcohol	30 seconds with agitation
18.	Xylene	1 minute with agitation
19.	Xylene	1 minute with agitation
20.	Xylene	3 minutes with agitation
21.	Coverslip slides	

Stains may be ordered from Thermo Fisher Scientific.

* Time may vary with stain lot or age.

8

FIXATION, STAINING, AND COVERSIPPING

SECTION D

COVERSLIPPING

Each laboratory should evaluate their choice of mounting media to insure compatibility with Thin-Prep slides.

Hologic recommends the use of 24mm x 40mm or 24mm x 50mm coverslips.

SECTION E

REFERENCES

Bales, CE. and Durfee, GR. *Cytologic Techniques* in Koss, L, ed. *Diagnostic Cytology and its Histopathologic Basis*. 3rd Edition. Philadelphia: JB Lippincott. Vol. II.

Chapter Nine

ThinPrep Pap Test Training Program

Objective

The ThinPrep[®] Pap Test Training Program was developed by Hologic to assist laboratories in the conversion process from the conventional Pap smear to the ThinPrep Pap Test. Hologic offers information, support and training for the conversion process, including communicating the change to the clinician, cytopreparatory training, ThinPrep Pap Test morphology training program and guidelines to assist with training the entire cytology staff in the laboratory.

Design

Morphology Training is designed to communicate the differences between the conventional Pap smear and the ThinPrep Pap Test. The participants use a series of slide modules to familiarize themselves with a spectrum of normal and abnormal cytological entities on ThinPrep Pap Test samples.

This program is based on a cumulative learning process. Interpreting the morphologic criteria of ThinPrep Pap Test samples requires review and application of cytology skills and knowledge. A systematic approach allows for frequent assessment of an individual's understanding of the ThinPrep characteristics. The training program incorporates both pre- and post-tests in order to assess learning progress.

The training begins with the ThinPrep morphology lecture, which is designed to familiarize the participants with the microscopic presentation of cervical samples prepared using the ThinPrep System. The format summarizes the morphologic features common to specific diagnostic entities described in *The Bethesda System for Reporting Cervical/Vaginal Cytologic Diagnoses*¹.

Following the introductory lecture, a module of known ThinPrep Pap Test cases are reviewed by all participants. This module presents a wide variety of diseases and disease states and provides the participant a base reference for the full range of diagnostic categories to be encountered. Review of "look-alike" cases is also included. Through the use of the ThinPrep Gyn Morphology Atlas, which highlights common diagnostic entities and their differential diagnoses, participants will begin to recognize key look-alike entities on ThinPrep slides and the criteria that can be used in their proper classification.

A series of modules of unknown ThinPrep Pap Test cases is used to assess the ThinPrep screening and interpretive skills of each participant. Participants are required to screen and diagnose each set of cases and record their results on the provided answer sheet. Once complete, the cases and correct responses are reviewed individually by each participant.

A final set of unknown ThinPrep Pap Test slides is provided. This final set of slides is modeled after current CLIA guidelines and will be scored by Hologic-designated personnel. Successful completion of these slides is necessary to receive a certificate of completion.



THINPREP PAP TEST TRAINING PROGRAM

CLIA Proficiency Test Program standards are used as guidelines in establishing pass/fail scoring criteria. Individuals receiving a 90% or better on the Final Assessment are qualified to screen/interpret ThinPrep Pap Test cases, and to begin training additional cytotechnologists and pathologists in their laboratory under the supervision of the laboratory Technical Supervisor, if needed. Participants of the training program receiving less than 90% on the Final Assessment would require remedial training in their individual laboratories. This training involves the screening/diagnosing of an additional ThinPrep Pap Test slide module provided by Hologic and requires a score of 90% or better to complete Hologic's ThinPrep Pap Test Training Program.

Cytology Staff Training

Hologic supports cytology staff training by providing information and resources, such as slides, answer sheets, and online educational material, for use by the lab in training additional staff. The laboratory Technical Supervisor is ultimately responsible for ensuring adequate training for individuals prior to screening and interpreting ThinPrep Pap Test cases.

Bibliography

Nayar R, Wilbur DC. (eds). *The Bethesda System for Reporting Cervical Cytology: Definitions, Criteria, and Explanatory Notes*. 3rd ed. Cham, Switzerland: Springer: 2015.

Index

Index



Index

A

Ancillary Testing 5A.2

B

blank sample 2.11
bleach 2.6, 5B.3, 5B.4, 5B.20
BloodBloc Super Absorbant Wipes 5B.3, 5B.6

C

Cell collection 1.3, 1.9
Cell transfer 1.3, 1.10
Chlamydia trachomatis 1.1
Clearances 1.13
Close Door to Continue Processing 6.4
COBAS AMPLICOR™ CT/NG Test 1.1
Collection
 Broom-like device 4.3
 Endocervical brush/Spatula device 4.4
Connect the waste bottle 2.6

D

Dimensions 1.13
Dispersion 1.3, 1.8
Disposal
 consumables 1.19
Door
 closing 5A.15, 5B.14

E

Environmental 1.14
Extended shutdown 2.12

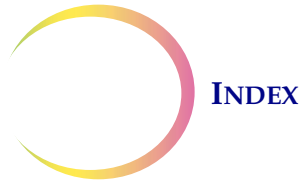

F

Filter 5A.4, 5B.2
 wetting 1.9
filter cap 5A.4, 5B.2
 preparing 5B.6
fixative vial 5A.4, 5B.2
Fuse 1.14, 2.8

H

Hazards 1.16

I

Insert Fix Bath to Continue Processing 6.6
Insert Slide to Continue Processing 6.8
Installation 2.1
Internal packaging removal 2.2
Interrupting slide processing 5A.20

L

Labels used on the instrument 1.18
Loading
 Fixative vial 5A.14, 5B.7
 PreservCyt Sample vial 5A.4, 5A.7, 5B.10
 ThinPrep Microscope Slide 5A.11, 5B.11
 ThinPrep Pap Test Filter 5A.8, 5B.8
Location selection 2.2
lubricant 4.5

M

Maintenance screen 5A.23
Material requirements 1.5, 5B.2

N

Neisseria gonorrhoeae 1.1



P

Power 1.14
Power cord 2.8
Power On Self Test 1.16
Program memory card 2.7

R

red blood cells 1.15
Remove Filter 6.10
Remove Fix Bath 6.12
Remove Fix Bath to Continue Processing 6.16
Remove Slide 6.14
Reprocessing following an 'Unsat' 4.7
Rotating plate 2.3

S

Sample Preparation Process 1.3
Sequences 5A.16
Slide handler 2.5
Status screen 5A.21
Storage and handling 2.12
Symbols used on the instrument 1.17

T

Technical specifications 1.12
Test screen 5A.25
Troubleshooting 6.1
Turning off the processor 2.12
Turning on the processor 2.9

U

UNLOADING 5B.19
Unloading
 fixative vial 5A.18
 PreservCyt Sample Vial 5B.18



INDEX

slide 5A.18, 5B.19

ThinPrep Pap Test filter 5A.18, 5B.20

V

voltage 1.14, 2.8

W

Warnings, Cautions, Notes 1.16

Weight 1.14

**ThinPrep 2000 System for
Non-Gynecologic Use**

**ThinPrep 2000 System for
Non-Gynecologic Use**



ThinPrep® 2000 System For Non-Gynecologic Use

Section 2 (blue tabs) contains information specific to the preparation of non-gynecologic samples. For all information related to the installation, operation, and maintenance of the ThinPrep® 2000 Processor, please refer to SECTION 1.



This page intentionally left blank.



Table of Contents

Chapter 1

NON-GYNECOLOGIC SAMPLE PREPARATION

SECTION A: Introduction	1.1
SECTION B: Contents	1.2
SECTION C: Required Materials	1.3
SECTION D: Details of Non-Gynecologic Sample Preparation Steps	1.4
SECTION E: Specimen Preparation Protocols	1.16
SECTION F: ThinPrep® UroCyte® Specimens	1.23
SECTION G: Sample Preparation Troubleshooting	1.26

Chapter 2

SOLUTIONS

SECTION A: Introduction	2.1
SECTION B: PreservCyt® Solution	2.2
SECTION C: CytoLyt® Solution	2.5
Solutions Storage Guide	



CONTENTS

This page intentionally left blank.

**1. Non-Gynecologic
Sample Preparation**

**1. Non-Gynecologic
Sample Preparation**

Chapter One

Non-Gynecologic Sample Preparation

SECTION**A****INTRODUCTION**

This chapter provides instructions for preparing non-gynecologic (non-gyn) samples and making slides with the ThinPrep® 2000 System. Non-gyn specimens include, but are not limited to: fine needle aspirates, FirstCyte® Breast Test specimens, urines, effusions, sputa, respiratory tract, gastrointestinal tract, etc.

For the best results, carefully follow the instructions in this chapter. Because there is biological variability among samples and variability in collection methods, standard processing may not always yield a satisfactory and uniformly distributed preparation on the first slide. This chapter contains troubleshooting instructions for further sample processing to obtain better quality subsequent slides in these cases. This chapter also provides an outline of various sample collection methods and the appropriate procedures for each.

In order to perform sample preparation for ThinPrep UroCyte® specimens, refer to Section F. Sample preparation troubleshooting as described in Section G has not been evaluated for ThinPrep UroCyte samples.



NON-GYNECOLOGIC SAMPLE PREPARATION

SECTION B

CONTENTS

This chapter is divided into the following five main sections and several sub-sections:

SECTION C: Required Materials

SECTION D: Details of non-gynecologic sample preparation steps

SECTION D-1: Collection

SECTION D-2: Concentrate by Centrifugation - 600g for 10 Min

SECTION D-3: Pour Off Supernatant and Vortex to Resuspend Cell Pellet

SECTION D-4: Evaluate Cell Pellet Appearance

SECTION D-5: Add Specimen to PreservCyt® Solution Vial

SECTION D-6: Allow to Stand in PreservCyt Solution for 15 Min

SECTION D-7: Run on ThinPrep® 2000 Processor Using Sequence n, Fix, Stain, and Evaluate

SECTION D-8: Mechanical Agitation

SECTION D-9: CytoLyt® Solution Wash

SECTION E: Specimen Preparation Protocols

SECTION E-1: Fine Needle Aspirates

SECTION E-2: Muroid Specimens

SECTION E-3: Body Fluids

SECTION E-4: Superficial Brushings And Scrapings

SECTION E-4: FirstCyte® Breast Test Specimens

SECTION F: ThinPrep® UroCyte® Specimens

SECTION G: Sample Preparation Troubleshooting

SECTION
C

REQUIRED MATERIALS

From Hologic:

- CytoLyt Solution
CytoLyt Tubes
CytoLyt Cups
CytoLyt Bottles (bulk)
- PreservCyt Solution
PreservCyt Vials
PreservCyt Bottles (bulk)
- Non-Gyn ThinPrep Filters (Blue)
- ThinPrep UroCyte® Filter (Yellow) for urine specimens
- ThinPrep UroCyte Microscope Slides for urine specimens
- ThinPrep UroCyte PreservCyt vials for urine specimens
- ThinPrep Microscope Slides
- ThinPrep 2000 Processor
- Multi-Mix™ Racked Vortexor

Note: Refer to the **Ordering Information** of the ThinPrep 2000 System Operator's Manual for more information about supplies and solutions from Hologic.

From Other Suppliers:

- 50ml capacity centrifuge (free swing basket)
- Centrifuge Tubes, 50ml
- Plastic transfer pipettes, 1ml, graduated
- Balanced electrolyte solutions
- Slide staining system and reagents
- Standard laboratory fixative
- Coverslips and mounting media
- Anticoagulant for needle aspirates
- Blender (optional)
- Glacial acetic acid (*troubleshooting only*)
- Saline (*troubleshooting only*)
- DiThioThreitol (DTT, optional, mucoid samples only)

1







NON-GYNECOLOGIC SAMPLE PREPARATION

SECTION D

DETAILS OF NON-GYNECOLOGIC SAMPLE PREPARATION STEPS

The following are the common steps for preparing a non-gynecologic sample with the ThinPrep 2000 System. Each step is explained in detail in the following sections.

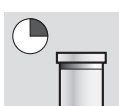
WARNING: Do not process a cerebral spinal fluid (CSF) specimen or other sample type that is suspected of possessing prion infectivity (PrPsc) derived from a person with a TSE, such as Creutzfeldt-Jakob disease, on the ThinPrep processor. A TSE-contaminated processor cannot be effectively decontaminated and therefore must be properly disposed of in order to avoid potential harm to users of the processor or service personnel.

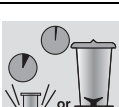
	D-1. Collection
	D-2. Concentrate by Centrifugation — 600g for 10 Minutes
	D-3. Pour Off Supernatant and Vortex to Resuspend Cell Pellet
	D-4. Evaluate Cell Pellet Appearance Refer to page 1.11.
	D-5. Add appropriate amount of Specimen to PreservCyt Solution Vial Refer to page 1.12.
	D-6. Allow to Stand in PreservCyt Solution for 15 Minutes
	D-7. Run on ThinPrep 2000 Processor using Sequence n, Fix, Stain, and Evaluate
	D-8. Mechanical Agitation (mucoïd samples only, optional)

	<p>D-9. CytoLyt Solution Wash (Some specimens do not require a CytoLyt wash. Refer to the specific specimen preparation protocol.)</p>
--	--

SECTION D-1 COLLECTION

Note: The ThinPrep® 2000 Processor is designed for use with PreservCyt® Solution. Do not run any other collection media through it.

Samples to be processed on the ThinPrep Processor will arrive in the lab either fresh or in CytoLyt Solution. There are preferred collection methods for different sample types. This section will describe the Hologic recommended procedure as well as alternate collection methods.

WARNING: For washes and lavages, do not expose the patient to CytoLyt Solution.



Fine Needle Aspirate Specimens:

The optimal collection technique for FNAs is to deposit and rinse the entire sample into a centrifuge tube containing 30ml of CytoLyt Solution. A secondary method would be to collect the sample into a balanced electrolyte solution, such as Polysol® or Plasma-Lyte® injection solutions.

Note: Direct smears may be necessary for radiologic-guided FNAs when a rapid analysis of specimen adequacy is required.

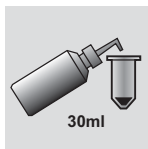

Mucoid Specimens:

Mucoid specimens, sputa and brushes, are best collected into CytoLyt Solution. If they are collected fresh, CytoLyt Solution should be added as soon as possible. Early addition of CytoLyt Solution preserves the sample and initiates the mucus dissolution process.

Large volume of fresh mucoid specimens (greater than 20ml) should be concentrated before addition of CytoLyt Solution to the sample.

1

NON-GYNECOLOGIC SAMPLE PREPARATION

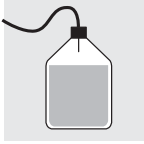

Fluid Specimens:

The preferred method for preparing fluid samples (urinary tract, effusions, synovial, and cyst fluids) is to concentrate the fresh sample before any addition of CytoLyt Solution. If this is not possible and the samples must be preserved for transport to the lab, collect the samples in CytoLyt Solution.

CytoLyt Solution added directly to fluids with high levels of protein may produce some degree of protein precipitation.

Note: Fluid collection in CytoLyt Solution is only considered a Collection Step and not a Wash Step. See “CYTOLYT SOLUTION WASH” on page 1.15, in this section for more detail.

The quantity of fluid samples can vary widely from less than 1ml to 1000ml and more. Each lab must follow its own procedure for determining the amount of sample to use for processing. If more than one centrifuge tube of sample is used, the cell pellets can be combined after pouring off the supernatant.



Superficial Specimens:

Superficial brushings and scrapings are the only non-gynecologic samples which are collected directly into PreservCyt Solution.

Other Collection Media:

In cases where CytoLyt Solution is contraindicated, balanced electrolyte solutions, such as Plasma-Lyte and Polysol, may be used as collection media for samples to be processed on the ThinPrep 2000 Processor. These solutions are primarily used as media for washings or lavages which contact the patient.

Non-Recommended Collection Media:

Hologic does not recommend the use of the following collection solutions with the ThinPrep System. Use of these solutions will produce sub-optimal results:

- Sacomanno and other solutions containing carbowax
- Alcohol
- Mucollex®
- Normal Saline
- Culture media, RPMI Solution
- PBS
- Solutions containing formalin



Specimens *must* be centrifuged and washed in CytoLyt® Solution and transferred to PreservCyt® Solution prior to being processed on the ThinPrep 2000 Processor.

Refer to Section D-9 on “CYTOLYT SOLUTION WASH” on page 1.15 for CytoLyt Solution wash instructions.

Note: See Chapter 2, "Solutions" for more information on CytoLyt Solution.

WARNING: CytoLyt Solution is a poison (contains methanol) and it must never come in direct contact with the patient.

1

NON-GYNECOLOGIC SAMPLE PREPARATION

SECTION D-2

CONCENTRATE BY CENTRIFUGATION - 600g for 10 Minutes

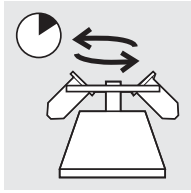

The purpose of this procedure is to concentrate the cellular material in order to separate the cellular component(s) from the supernatant. This step is performed with fresh samples and after the addition of CytoLyt Solution. When specified in the protocol, centrifuge samples at 600 times normal gravity (600g) for 10 minutes to force the cells in solution into a pellet at the bottom of the centrifuge tube.

Set your centrifuge to the approximate number of revolutions per minute (rpm) to spin the cells at 600g.

Follow these steps to determine the correct setting for your centrifuge:

Caution: Check cell morphology on non-critical experimental samples before making any changes to your centrifugation process.

Note: Use of fixed-angle centrifuges is not recommended.

Measure the rotor length of your centrifuge.

Use a centimeter ruler to measure the radius of your centrifuge, the distance from the center of the rotor to the bottom of the bucket extended horizontally as shown in Figure 1-1.

Figure 1-1 Measuring the Centrifuge

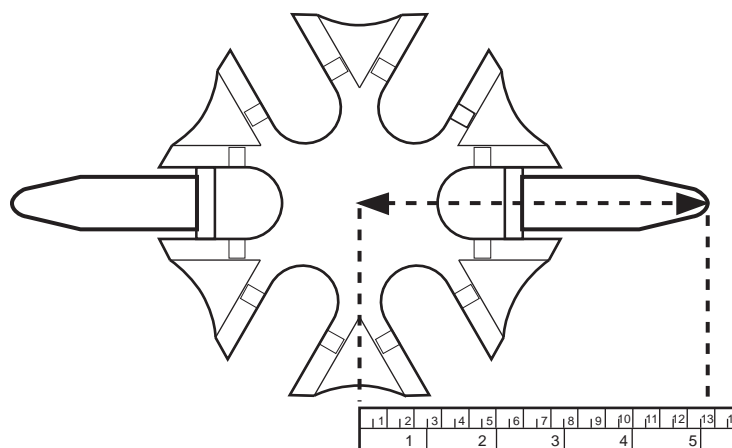

Refer to the chart in Figure 1-2

Find the radius of your centrifuge in the first column of Figure 1-2. Draw a line from the radius value through the 600 Gravities (g) column and into the rpm column. Read the rpm

value from the straight edge as shown in Figure 1-2. Run your centrifuge at this speed to achieve a force of 600g on your samples.

Figure 1-2 Determining the Correct Centrifuge Speed

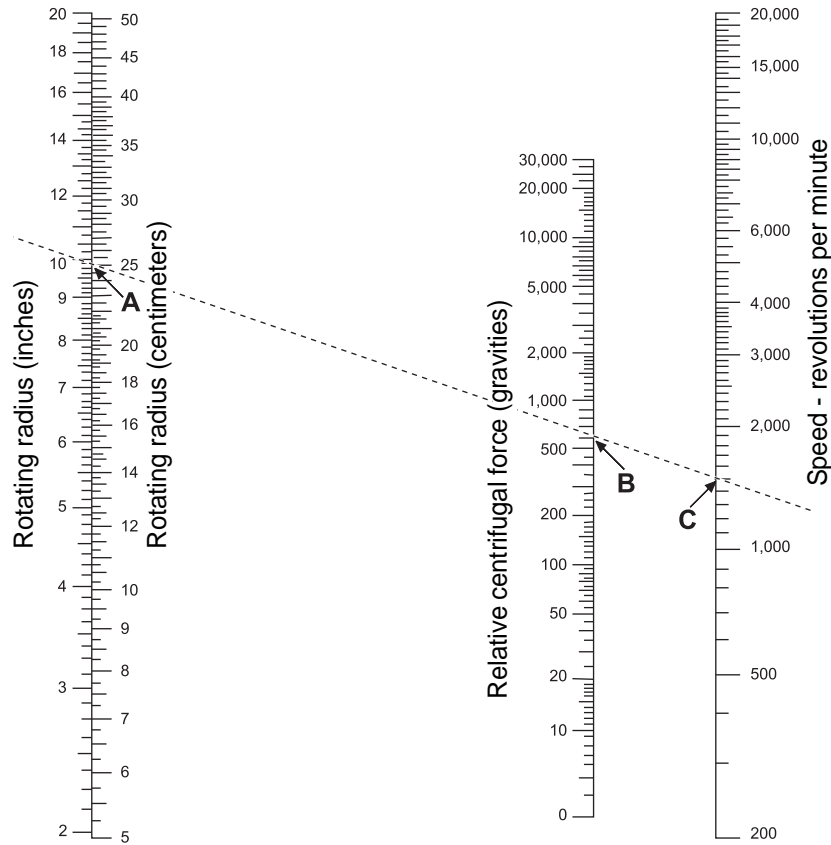

To reduce the time required for the centrifugation step, operate your centrifuge at 1200g for 5 minutes.

1

NON-GYNECOLOGIC SAMPLE PREPARATION

SECTION D-3

POUR OFF SUPERNATANT AND VORTEX TO RESUSPEND CELL PELLET

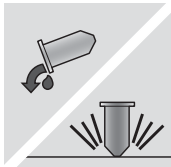

Pour off the supernatant completely to effectively concentrate the sample. To do this, invert the centrifuge tube 180 degrees in one smooth movement, pour off all the supernatant, and then return the tube to its original position as shown in Figure 1-3.¹ Observe the cell pellet during inversion to avoid accidental loss of cellular material.

Caution: Failure to completely pour off the supernatant may produce a sparse sample and an unsatisfactory slide due to dilution of the cell pellet.

Figure 1-3 Pouring Off Supernatant

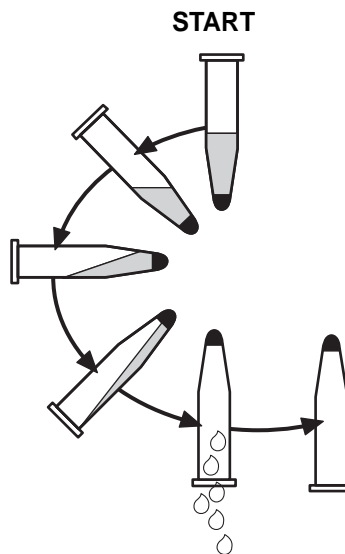

After pouring off the supernatant, place the centrifuge tube onto a vortexer and agitate the cell pellet for 3 seconds. Manual vortexing may be achieved by syringing the pellet back and forth with a plastic pipette. The intention of this vortexing step is to randomize the cell pellet before transferring to the PreservCyt Solution vial and to improve the results of the CytoLyt Solution washing procedure.

1 Refer to Bales, CE, and Durfee, GR. *Cytologic Techniques* in Koss, L. ed. *Diagnostic Cytology and its Histopathologic Basis*. 3rd Edition. Philadelphia: JB Lippincott. Vol. II: pp. 1187–12600 for details.

SECTION
D-4

EVALUATE CELL PELLETS APPEARANCE

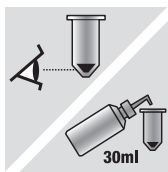

Appearance of Cell Pellet	Procedure
Cell pellet is white, pale pink, tan, or not visible.	Add Specimen to PreservCyt Solution Vial See Section D-5 in this Chapter
Cell pellet is distinctly red or brown indicating the presence of blood.	Cytolyt Solution Wash See Section D-9 in this Chapter <ul style="list-style-type: none"> • Add 30ml Cytolyt Solution • Concentrate by Centrifugation • Pour Off Supernatant and Vortex to Resuspend Cell Pellet
Cell pellet is mucoid (not in liquid form). To test for liquid form, draw a small amount of the sample into a pipette and deliver drops back into the tube. If the drops appear stringy or gelatinous, then the mucus must be further liquefied.	Cytolyt Solution Wash See Section D-9 in this Chapter <ul style="list-style-type: none"> • Add 30ml Cytolyt Solution • Mechanical Agitation • Concentrate by Centrifugation • Pour Off Supernatant and Vortex to Resuspend Cell Pellet

1



NON-GYNECOLOGIC SAMPLE PREPARATION

SECTION D-5

ADD SPECIMEN TO PRESERVCYT SOLUTION VIAL



Determine the cell pellet size and refer to the table below:

	Size of Cell Pellet	Procedure
	Pellet is clearly visible and the pellet volume is less than 1ml.	Place the centrifuge tube in a vortexor to resuspend the cells in the residual liquid or mix the pellet by syringing it manually with a pipette. Transfer 2 drops of the pellet to a fresh PreservCyt Solution Vial.
	Pellet is not visible or is scant.	Add the contents of a fresh PreservCyt Solution Vial (20ml) into the tube. Vortex briefly to mix the solution and pour the entire sample back into the PreservCyt Solution Vial.
	Pellet volume is greater than 1ml.	Add 1ml of CytoLyt Solution into the tube. Vortex briefly to resuspend the pellet. Transfer 1 drop of the specimen to a fresh PreservCyt Solution Vial.

Factors to Consider

The type of pipette that you use may affect the concentration of the sample that is added to the PreservCyt Solution Vial, and therefore may affect the volume of sample. Hologic recommends using standard, 1ml, graduated, plastic pipettes.

If a "Sample Is Dilute" message occurs repeatedly and specimen remains in the specimen tube, increase the number of drops of concentrated sample added to the vial.

Your technique for pouring off the supernatant may also affect the concentration of the sample. If the supernatant is not completely poured off, then additional drops of the sample may be required. The total volume added to the vial must not exceed 1ml.

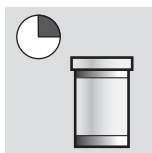
SECTION
D-6**ALLOW TO STAND IN PRESERVCYT SOLUTION FOR
15 MINUTES**

After sample transfer to the PreservCyt Solution Vial, the sample should stand for at least 15 minutes before processing to allow the PreservCyt Solution to render the sample non-infectious.

For more information on PreservCyt Solution, refer to Chapter 2, "Solutions".

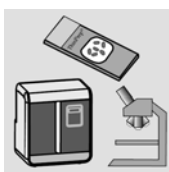
SECTION
D-7**RUN ON THINPREP PROCESSOR USING SEQUENCE n,
FIX, STAIN, AND EVALUATE**

After the sample has been in contact with PreservCyt Solution for 15 minutes, it may be processed on the ThinPrep 2000 Processor. The operator loads the instrument and selects the appropriate sequence number (sequence 'n') for the sample to be processed as described in SECTION 1: Chapter 5A, "Operating Instructions".

At the completion of the process, the operator fixes and stains the slide according to the procedure in SECTION 1: Chapter 8, "Fixation, Staining, and Coverslipping".

When the slide is stained and coverslipped, it is microscopically reviewed by a cytotechnologist or pathologist. If the slide appears unsatisfactory after microscopic review, another slide may be made from the specimen using the Sample Preparation Troubleshooting procedures in Section F of this chapter.

1

NON-GYNECOLOGIC SAMPLE PREPARATION

SECTION D-8

MECHANICAL AGITATION

Mucoid specimens require vigorous agitation in CytoLyt Solution to break up the mucus. Hologic recommends two methods of mechanical agitation:

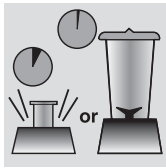

Method A:

Vortex the CytoLyt/Sample mixture for at least 5 minutes on a “hands-free” vortexor. The vortexor speed must be adjusted to produce visible agitation to the bottom of the tube.

Method B:

Blend the CytoLyt/Sample mixture for a few seconds.

Note: Agitation times for both methods may vary due to differences in specimen consistency.

The blending technique may show fragmentation or disruption of cell architecture. Excessive blending must be avoided.

Vortexing for at least 5 minutes after blending helps break up more mucus.

SECTION
D-9

CYTOLYT SOLUTION WASH

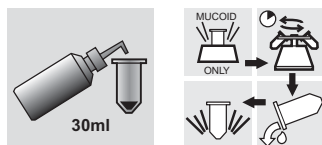

Addition of CytoLyt Solution to cell pellets is required to wash the sample. A **CytoLyt Solution Wash** performs the following functions while preserving cellular morphology:

- Lyse red blood cells
- Dissolve mucus
- Reduce protein precipitation

A **CytoLyt Solution Wash** consists of the following process:

- Adding 30ml of CytoLyt Solution to a cell pellet
- *Mucoid Specimens Only: Mechanical agitation*
- Concentration by centrifugation — 600g x 10 Minutes
- Pouring off the supernatant and vortexing to resuspend the cell pellet

One **CytoLyt Solution Wash** is usually adequate to clean most non-gyn samples. For particularly bloody or mucoid specimens, additional **CytoLyt Solution Washes** may be necessary.

When a sample is collected in CytoLyt Solution at a ratio less than 30 parts CytoLyt Solution to 1 part sample, this is considered a *Collection Step* and not a *Wash Step*. For example, if one collects 15ml of a sample and adds 30ml of CytoLyt Solution to this sample, then the CytoLyt: sample ratio is only 2 to 1 and this is considered a sample collection step and still requires a **CytoLyt Solution Wash**.

For more information on CytoLyt Solution, refer to Chapter 2, "Solutions".



NON-GYNECOLOGIC SAMPLE PREPARATION







SPECIMEN PREPARATION PROTOCOLS

The following protocols outline the preferred methods for preparing the different types of specimens. The methods are described in general terms. For more detailed information about each step, refer to Section D in this Chapter. Section G provides troubleshooting for sample preparation.

SECTION
E-1

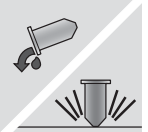
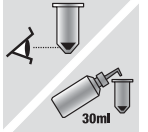
FINE NEEDLE ASPIRATES (FNA)

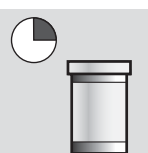
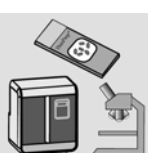
	<p>1. Collection: Collect sample directly into 30ml of CytoLyt Solution. If specimen must be collected in an intravenous solution, use a balanced electrolyte solution.</p> <p>Note: If possible, flush the needle and syringe with a sterile anticoagulant solution prior to aspirating the sample. Some anticoagulants may interfere with other cell processing techniques, so use caution if you plan to use the specimen for other testing.</p>
	<p>2. Concentrate by Centrifugation — 600g for 10 Minutes or 1200 g for 5 Minutes.</p>
	<p>3. Pour Off Supernatant and Vortex to Resuspend Cell Pellet</p>
	<p>4. Evaluate Cell Pellet Appearance Refer to page 1.11. If cell pellet is not free of blood, add 30ml of CytoLyt Solution to cell pellet and repeat from step 2.</p>
	<p>5. Add appropriate amount of Specimen to PreservCyt Solution Vial Refer to page 1.12.</p>
	<p>6. Allow to Stand in PreservCyt Solution for 15 Minutes</p>
	<p>7. Run on ThinPrep 2000 Processor using Sequence 2. Fix, Stain, and Evaluate.</p>





1

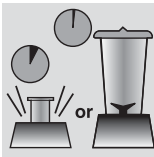

NON-GYNECOLOGIC SAMPLE PREPARATION

SECTION E-2

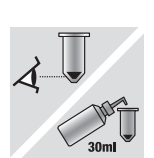
MUCOID SPECIMENS

Mucoid Specimens may include respiratory and gastrointestinal specimens.

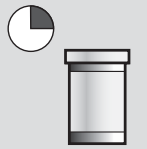
 <p>30ml</p>	<p>1. Collection: Collect sample directly into 30ml of CytoLyt Solution. OR Add 30ml of CytoLyt Solution to the fresh specimen as soon as possible.</p> <p>Note: Large specimens (greater than 20ml) should be concentrated before addition of CytoLyt Solution to the sample.</p>
<p>Optional:</p>	<p>If DTT is being used with respiratory mucoid samples, add stock before agitation. See the following page for preparation instructions.</p>
	<p>2. Mechanical Agitation</p> <p>Note: Vortex for a minimum of 5 minutes in “hands-free” vortexor.</p>
	<p>3. Concentrate by Centrifugation — 600g for 10 Minutes or 1200 g for 5 Minutes.</p>
	<p>4. Pour Off Supernatant and Vortex to Resuspend Cell Pellet</p>
 <p>30ml</p>	<p>5. Evaluate Cell Pellet Appearance</p> <p>Refer to page 1.11. Confirm the cell pellet is in liquid form. If the cell pellet is not in liquid form, add 30ml of CytoLyt Solution and repeat steps 2-4.</p>
	<p>6. Add appropriate amount of Specimen to PreservCyt Solution Vial.</p> <p>Refer to page 1.12.</p>

	7. Allow to Stand in PreservCyt Solution for 15 Minutes
	8. Run on ThinPrep 2000 Processor using Sequence 3 . Fix, Stain, and Evaluate.

Procedure for the Use of DiThioThreitol (DTT) with Mucoïd Non-Gyn Samples

DTT has been shown to be a reagent that is effective in reducing the amount of mucus in respiratory samples.^{1,2}

DTT Stock Solution

- Prepare a stock solution by adding 2.5 g DTT³ to 30 ml of CytoLyt Solution.
- This solution is suitable for use for 1 week when stored at room temperature (15° - 30°C).

Sample Preparation

- This procedure is designed for mucoïd non-gyn sample processing. Follow the steps for processing mucoïd specimens on the previous page.
- After sample collection (Step 1), but prior to vortexing (Step 2), add 1 ml of the stock DTT solution to the sample.
- Proceed with the remaining sample processing steps as listed.

1. Tockman, MS et al., 'Safe Separation of Sputum Cells from Mucoïd Glycoprotein' Acta Cytologica 39, 1128 (1995).
 2. Tang, C-S, Tang CMC and Kung, TM, 'Dithiothreitol Homogenization of Prefixed Sputum for Lung Cancer Detection', Diagn. Cytopathol. 10, 76 (1994).
 3. Available from Amresco, contact a sales representative at 800-448-4442 or www.amresco-inc.com.





1



NON-GYNECOLOGIC SAMPLE PREPARATION

SECTION E-3

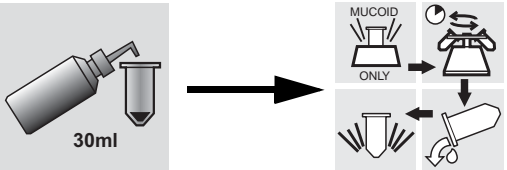
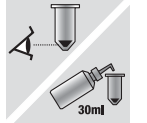
BODY FLUIDS

Body Fluids may include serous effusions, urinary and cerebrospinal fluids.

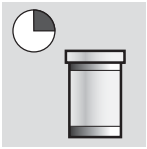



	<p>1. Collection: Collect body fluids fresh.</p> <p>Note: Fluids collected in CytoLyt Solution also require a CytoLyt Solution Wash prior to instrument processing.</p> <p>Note: For extremely bloody fluids (i.e., pericardial), start with only 10ml of fresh fluid.</p> <p>Note: Urine may be collected into PreservCyt Solution utilizing the ThinPrep® UroCyt Urine Collection Kit. (Refer to Section F for details.)</p>
	<p>2. Concentrate by Centrifugation — 600g for 10 Minutes or 1200 g for 5 Minutes.</p>
	<p>3. Pour Off Supernatant and Vortex to Resuspend Cell Pellet</p>
 <p>4. CytoLyt Solution Wash</p>	
	<p>5. Evaluate Cell Pellet Appearance</p> <p>Refer to page 1.11.</p> <p>If cell pellet is not free of blood, add 30ml of CytoLyt solution to cell pellet and repeat from step 2.</p>
	<p>6. Add appropriate amount of Specimen to PreservCyt Solution Vial.</p> <p>Refer to page 1.12.</p>

	<p>7. Allow to Stand in PreservCyt Solution for 15 Minutes</p>
	<p>8. Run on ThinPrep 2000 Processor using Sequence 2. Fix, Stain, and Evaluate.</p>

SECTION
E-4

SUPERFICIAL BRUSHINGS AND SCRAPINGS

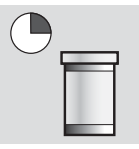
Superficial brushings and scrapings include oral cavity specimens, nipple secretions, skin lesions (Tzanck Test), and eye brushings.

	<p>1. Collection: Deposit the specimen directly into a PreservCyt Solution Vial.</p>
	<p>2. Gently shake the PreservCyt Sample Vial to mix the contents</p>
	<p>3. Allow to Stand in PreservCyt Solution for 15 Minutes</p>
	<p>4. Run on ThinPrep 2000 Processor using Sequence 1. Fix, Stain, and Evaluate.</p>







1

NON-GYNECOLOGIC SAMPLE PREPARATION

SECTION E-5

FIRSTCYTE® BREAST TEST SPECIMENS

Specimens collected via FirstCyte Breast Test.

	<p>1. Collection: Collect sample directly into 30ml of CytoLyt Solution in the CytoLyt tube.</p>
	<p>2. Concentrate by Centrifugation - 600g for 10 Minutes.</p>
	<p>3. Pour Off Supernatant and Resuspend Cell Pellet. Resuspension can be done on a vortexor or may be achieved by syringing the pellet back and forth with a plastic pipette.</p>
	<p>4. Add PreservCyt from a PreservCyt Solution Vial. Cap the tube tightly and mix by inversion to resuspend all the cells.</p>
	<p>5. Add appropriate amount of specimen to PreservCyt Solution Vial. Refer to page 1.12. Allow to stand in PreservCyt Solution for 15 Minutes.</p>
	<p>6. Run on ThinPrep 2000 Processor using Sequence 2, Fix, Stain and Evaluate.</p>

SECTION F THINPREP® UROCYTE® SPECIMENS



Your ThinPrep 2000 Processor does not currently support UroCyt^e sample preparation. In order to process UroCyt^e samples using this system, additional software must be obtained. Please refer to the ordering information section of this manual or call Customer Service at 1-508-263-2900 for more information.

(For use with urine cytology processing or slide-based molecular testing.)

	<p>1. Collection. Collect urine directly into the ThinPrep UroCyt^e Urine collection kit, OR process urine fresh.</p> <p>Note: Fresh urine can be mixed with a 2:1 urine-to-PreservCyt[®] Solution ratio and stored for up to 48 hours before processing.</p> <p>Note: If using the UroCyt^e Urine Collection Kit, do not exceed a 2:1 ratio of urine to PreservCyt Solution. If the urine volume exceeds 60ml, pour off excess. A minimum volume of 33ml of urine is required to perform the Vysis[®] UroVysion assay.</p>
	<p>2. Concentrate by Centrifugation.</p> <p>Transfer the sample evenly into two labeled to 50ml centrifuge tubes.</p> <p>Centrifuge at 600g for 10 minutes or 1200 g for 5 minutes.</p>
	<p>3. Pour Off Supernatant and Resuspend Cell Pellet</p> <p>Resuspension can be done on a vortexor or may be achieved by syringing the pellet back and forth with a plastic pipette.</p>
	<p>4. CytoLyt[®] Solution Wash.</p> <p>Add 30 ml of CytoLyt Solution to one 50ml centrifuge tube and vortex. Transfer the contents of this tube into the second 50 ml centrifuge tube and vortex. The specimen is now combined into one 50ml tube. The empty tube can be discarded.</p> <p>Centrifuge.</p> <p>Pour off Supernatant.</p> <p>Resuspend Cell Pellet.</p>



1

NON-GYNECOLOGIC SAMPLE PREPARATION

	<p>5. Evaluate Cell Pellet Appearance. Refer to page 1.11. If the cell pellet is not free of blood, add 30ml of CytoLyt Solution and repeat from step 4.</p>
	<p>6. Add Entire Specimen to PreservCyt® Solution Vial. Allow to stand in PreservCyt Solution for 15 minutes.</p>
	<p>7. Run on ThinPrep® 2000 Processor Using Sequence 5 (UroCyt). Fix, stain, and evaluate cytology, OR perform the molecular diagnostic testing according to the manufacturer's instructions for use.</p>

Instructions for using the ThinPrep UroCyt Urine collection kit.

Note: The specimen collection cup has a blue cap. The PreservCyt Solution vial has a white cap.

	<p>1. On the specimen collection cup, record patient information in the space provided.</p>
	<p>2. Collect urine in a routine manner. If urine volume exceeds 60ml, pour off excess. The total volume of urine must not exceed 60ml. A minimum of 33ml of urine is required to perform the Vysis® UroVysion assay.</p>

NON-GYNECOLOGIC SAMPLE PREPARATION



An illustration showing a small vial being tilted to pour its contents into a specimen cup. The cup is already containing some liquid. A blue cap is shown nearby.	<p>3. After the urine is collected, carefully pour PreservCyt Solution into specimen cup containing urine. Do not spill PreservCyt Solution.</p>
An illustration of a hand holding a specimen cup with a blue cap. Two curved arrows above the hand indicate the direction of rotation to tighten the cap.	<p>4. Tightly secure blue cap on specimen cup to prevent leakage. (Keep turning for another 1/4 inch after you hear the audible click).</p>
An illustration showing a specimen cup with its cap on, placed inside a white biohazard bag. Two orange absorbent pads are also visible inside the bag.	<p>5. Place cup and absorbent pads into biohazard bag. Tightly seal bag.</p> <p>6. Store between 4°C and 30° C (39°F - 86°F). Preferred storage and shipping conditions are on ice packs (e.g., blue ice in styrofoam). Specimen must be processed within 48 hours. Transport the specimen according to your internal procedures.</p>

1

NON-GYNECOLOGIC SAMPLE PREPARATION

SECTION G

SAMPLE PREPARATION TROUBLESHOOTING

Because there is biological variability among samples and variability in collection methods, standard processing may not always yield a satisfactory and uniformly distributed preparation on the first slide. This section contains instructions for further sample processing to obtain better quality subsequent slides in these cases.



After staining, you may observe the following irregularities:

- Non-uniform distribution of the cells in the cell spot that was not accompanied by a “Sample Is Dilute” message.
- Uneven distribution in the form of a ring or “halo” of cellular material and/or white blood cells
- A sparse cell spot lacking in a cellular component and containing blood, protein, and debris. This type of slide may be accompanied by a “Sample Is Dilute” message.

Note: Satisfactory slide appearance is a matter of judgment and experience. Hologic recommends that you check the quality of the slide after staining. If you determine that the slide is unsatisfactory, use the procedures in this section to make additional slides.



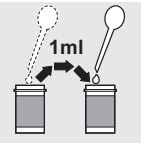
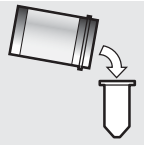
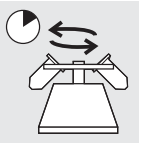



Caution: Be sure to use a new Non-Gynecologic Filter for each slide.

Bloody or Proteinaceous Specimens



Problem	Procedure	
A. Did the “Sample Is Dilute” message appear during processing? NO ↓ YES ⇒	1. Check to see if cellularity is adequate. If not, use more of the pellet if available. Prepare a slide using Sequence 2. 	
B. Does the slide have an obvious “halo” of cellular material and/or white blood cells? NO ↓ YES ⇒	1. Dilute the sample 20:1. Use a calibrated pipette to add 1ml of sample to a new PreservCyt Solution vial. Prepare slide using Sequence 1. If a halo is present on the new slide, call Hologic Technical Support. 	
C. Is the slide sparse and does it contain blood, protein, or non-cellular debris? NO ↓ YES ⇒	1. Pour the contents of the PreservCyt Sample vial into a centrifuge tube. 	
Call Hologic Technical Support.	2. Concentrate by Centrifugation — 600 g for 10 min. or 1200 g for 5 min. 	
	3. Pour Off Supernatant and Vortex to Resuspend Cell Pellet. 	
	4. If the sample contains blood or non-cellular debris: Mix a solution of 9 parts CytoLyt Solution to 1 part Glacial acetic acid. Add 30ml of this solution to the sample centrifuge tube. If the sample contains protein: Add 30ml of saline to the sample centrifuge tube. 	

1

NON-GYNECOLOGIC SAMPLE PREPARATION

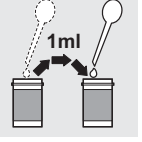
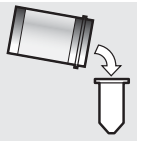

Problem	Procedure	
	5. Concentrate by Centrifugation. 600 g for 10 min. or 1200 g for 5 min.	
	6. Pour Off Supernatant and Vortex to Resuspend Cell Pellet.	
	7. Evaluate Cell Pellet Appearance. Refer to page 1.11. If pellet contains blood or protein, repeat from step 4.	
	8. Add appropriate amount of Specimen to PreservCyt Solution Vial. Refer to page 1.12.	
	9. Run on ThinPrep 2000 Processor using Sequence 2. Fix, Stain, and Evaluate.	
	10. If the new slide is sparse, call Hologic Technical Support.	

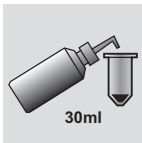
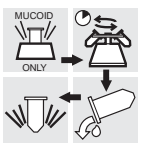
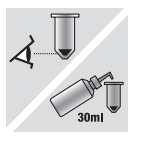
Mucoid Specimens

Problem	Procedure	
A. Did the "Sample Is Dilute" message appear during processing? NO ↓ YES ⇒	1. Check to see if cellularity is adequate. If not, use more of the pellet if available. Prepare a slide using Sequence 3. 	
B. Does the slide have an obvious "halo" of cellular material and/or white blood cells? NO ↓ YES ⇒	1. Dilute the sample 20:1. Use a calibrated pipette to add 1 ml of sample to a new PreservCyt Solution vial. Prepare slide using Sequence 1. If a halo is present on the new slide, call Hologic Technical Support. 	
C. Is the slide sparse and does it contain mucus? NO ↓ YES ⇒	1. Pour the contents of the PreservCyt Sample vial into a centrifuge tube. 	
Call Hologic Technical Support.	2. Concentrate by Centrifugation. 600 g for 10 min. or 1200 g for 5 min. 	
	3. Pour Off Supernatant and Vortex to Resuspend Cell Pellet. 	
	4. CytoLyt Solution Wash  	
	5. Evaluate Cell Pellet Appearance. Refer to page 1.11. If pellet contains mucus, repeat from step 4. 	

1

NON-GYNECOLOGIC SAMPLE PREPARATION

Problem	Procedure	
	6. Add appropriate amount of Specimen to PreservCyt Solution Vial. Refer to page 1.12.	
	7. Run on ThinPrep 2000 Processor using Sequence 2. Fix, Stain, and Evaluate.	
	8. If the new slide is sparse, call Hologic Technical Support.	

Common Artifacts

Smudged Nuclear Detail

The chromatin detail of nuclei can appear smudged if saline, PBS, or RPMI are used as the collection fluids. To avoid this problem, collect the sample either fresh, in CytoLyt Solution, or in a balanced electrolyte solution. Refer to Section E-1 of this chapter for more detail on collection fluids.

Halo Artifact

In some cases of dense specimens, only the outer edge of cellular material may transfer to the Thin-Prep slide forming a “halo” or ring of cellular material on the slide. If the slide is not satisfactory, a second slide may be produced following the sample preparation troubleshooting procedures on the previous page.

Compression Artifact

Some samples may display what appears to be “air-dry” artifact on the perimeter of the cell spot. This artifact is not air-drying but rather it is due to the compression of cells between the edge of the Filter and the glass slide.

Staining Artifact

Some samples may display a staining artifact which mimics air-drying in appearance. This artifact appears as a red or orange central staining primarily in cell clusters or groups. This artifact is due to incomplete rinsing of the counterstains. Fresh alcohol baths or an additional rinse step after the cytoplasmic stains is required to eliminate this artifact.

Edge of the Cylinder Artifact

Some samples may display a narrow rim of cellular material just beyond the circumference of the cell spot. This artifact is a result of cells from the outer edge of the wet filter cylinder being transferred to the glass slide. This may be more evident on highly cellular samples because there will be more cells to be transferred in the liquid.



NON-GYNECOLOGIC SAMPLE PREPARATION

Techniques Used in Troubleshooting

Diluting the Sample 20 to 1

To dilute a sample suspended in PreservCyt Solution, add 1ml of the sample that is suspended in PreservCyt Solution to a new PreservCyt Solution Vial (20ml). This is most accurately done with a calibrated pipette.

You may also simply count drops from an uncalibrated plastic pipette if you know how many drops correspond to 1ml. To calculate this, count out drops of PreservCyt Solution into a container of known volume. When the known volume is reached, divide the number of drops by the volume (in ml) to get the number of drops that corresponds to 1ml. Use PreservCyt Solution rather than any other liquid so the drop size will be consistent with the sample drops.

Glacial Acetic Acid Wash for Blood and Non-Cellular Debris

If a sample is found to be bloody during microscopic review, it can be further washed using a solution of 9 parts CytoLyt Solution and 1 part Glacial acetic acid. This should only be done after the sample has been in PreservCyt Solution. Do not use directly with fresh specimens; nuclear morphology may not be adequately preserved.

Saline Wash for Protein

If a sample is found to contain protein during microscopic review, it can be further washed using saline solution in place of CytoLyt Solution. This should only be done after the sample has been in PreservCyt Solution. Do not use directly with fresh specimens; nuclear morphology may not be adequately preserved.

Chapter Two

Solutions

SECTION
A

INTRODUCTION

The following sections describe the function and specifications of the two cytologic preservative fluids: PreservCyt[®] Solution and CytoLyt[®] Solution.

2 SOLUTIONS

SECTION B

PRESERVCYT® SOLUTION

PreservCyt Solution is a methanol-based, buffered solution designed to preserve cells during transport and slide preparation on the ThinPrep® 2000 Processor.

The ThinPrep Processor slide preparation process also requires PreservCyt Solution for transporting and storing samples prior to processing. PreservCyt Solution is optimized for the ThinPrep Processor slide preparation process and cannot be substituted with any other reagents.

Packaging

Please refer to the **Ordering Information** portion of this Manual for part numbers and detailed information regarding the ordering of solutions and supplies for the ThinPrep 2000 System.

- Vials (20 ml) of PreservCyt Solution are contained in each ThinPrep Pap Test.

Composition

PreservCyt Solution contains buffered methanol. It contains no reactive ingredients. It contains no active ingredients.

WARNING: Danger. PreservCyt Solution contains methanol. Toxic if swallowed. Toxic if inhaled. Causes damage to organs. Cannot be made non-poisonous. Keep away from heat, sparks, open flames and hot surfaces. Other solutions cannot be substituted for PreservCyt Solution.

Storage Requirements

- Store PreservCyt Solution between 15° C (59° F) and 30°C (86°F). Do not use beyond the expiration date printed on the container.
- Store PreservCyt Solution *with* non-gynecological cytologic sample between 4°C (39° F) and 37°C (98°F) for up to 3 weeks.
- Storage requirements for quantities of PreservCyt Solution are dependent on the size and configuration of your facility. Please refer to the Solution Storage Guide at the end of this chapter.

Transportation

When transporting a PreservCyt Solution vial containing cells, make sure the vial is tightly sealed. Align the mark on the cap with the mark on the vial to prevent leakage as shown in Figure 2-1. If the cap on the vial does not have a line, ensure the cap is tightened securely.

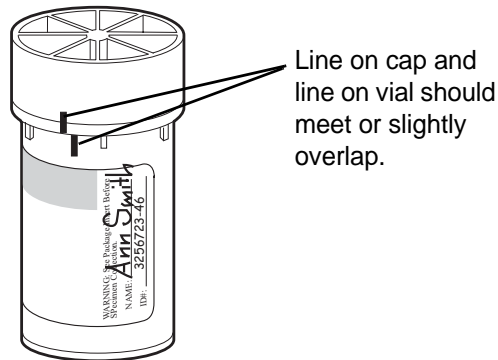
Figure 2-1 Aligning the vial cap

The shipping category for PreservCyt Solution is:

“flammable liquids, n.o.s. (methanol)” (USA only)

“flammable liquids, toxic, n.o.s. (methanol) (outside the USA)

The shipping category for PreservCyt Solution containing cells is “diagnostic sample.”

Please refer to the Shipping Requirements and Recommendations guide at the end of this chapter.

Stability

Do not use PreservCyt Solution after the expiration date on the container label. If making multiple slides from the same sample vial, be sure to make the slides before the expiration date marked on the sample vial. Expired vials should be discarded using appropriate laboratory procedures. Also, refer to storage requirements (page 2.2) for cell preservation limits.

Handling/Disposal

Handle all chemical-containing materials carefully in accordance with safe laboratory practices. When required by reagent composition, additional precautions are marked on the reagent containers.

Dispose of PreservCyt Solution according to the guidelines for disposing of hazardous waste. PreservCyt Solution contains methanol.

PreservCyt Solution was challenged with a variety of microbial and viral organisms. The following table presents the starting concentrations of viable organisms and the number of viable organisms

found after 15 minutes in the PreservCyt Solution. The log reduction of viable organisms is also presented. As with all laboratory procedures, universal precautions should be followed.

Organism	Initial Concentration	Log Reduction after 15 min.
Candida albicans	5.5 x 10 ⁵ CFU/mL	>4.7
Aspergillus niger*	4.8 x 10 ⁵ CFU/mL	2.7
Escherichia coli	2.8 x 10 ⁵ CFU/mL	>4.4
Staphylococcus aureus	2.3 x 10 ⁵ CFU/mL	>4.4
Pseudomonas aeruginosa	2.5 x 10 ⁵ CFU/mL	>4.4
Mycobacterium tuberculosis**	9.4 x 10 ⁵ CFU/mL	4.9
Rabbitpox virus	6.0 x 10 ⁶ PFU/mL	5.5***
HIV-1	1.0 x 10 ^{7.5} TCID ₅₀ /mL	7.0***

* After 1 hour >4.7 log reduction

** After 1 hour >5.7 log reduction

*** Data is for 5 minutes

Interfering Substances

The use of lubricants (e.g., KY Jelly) should be avoided prior to specimen collection. Lubricants can adhere to the filter membrane and may cause poor cell transfer to the slide. If its use is unavoidable, the lubricant should be used in minimum amounts.

SECTION
C

CYTOLYT® SOLUTION

CytoLyt Solution is a methanol-based, buffered, preservative solution designed to lyse red blood cells, prevent protein precipitation, dissolve mucus, and preserve morphology of general cytology samples. It is intended as a transportation medium and is used in specimen preparation prior to processing. It is not intended for complete inactivation of microbes. Chapter 1, "Non-Gynecologic Sample Preparation", describes the uses of CytoLyt Solution in detail.

Packaging

Please refer to the **Ordering Information** section of the ThinPrep 2000 System Operator's Manual for part numbers and detailed information regarding the ordering of solutions and supplies for the ThinPrep 2000 System.

- Box of 4 bottles each containing 1 quart (946ml) of CytoLyt Solution
- A dispensing pump which attaches to the quart bottles to dispense 30ml of liquid
- Box of 80, 50ml centrifuge tubes each containing 30ml (approx. 1 oz) of CytoLyt Solution
- Box of 50, 120ml specimen cups each containing 30ml (approx. 1 oz) of CytoLyt Solution

Composition

CytoLyt Solution contains methanol and buffer.

WARNING: Danger. CytoLyt Solution contains methanol. Harmful if swallowed. Harmful if inhaled. Causes damage to organs. Cannot be made non-poisonous. Flammable liquid and vapor.

Storage Requirements

- Store the containers at 15°– 30°C without cells.
- Cells in CytoLyt Solution are preserved for 8 days at room temperature; however, for best results, transport specimen to the laboratory immediately for processing. This 8-day preservation period pertains to samples in a minimum CytoLyt Solution to sample ratio of one part CytoLyt Solution to three parts sample.
- Storage requirements for quantities of CytoLyt Solution are dependent on local regulations regarding the size and configuration of your facility. Please refer to the Solution Storage Guide at the end of this chapter.

Transportation

Make sure the tubes and specimen cups containing CytoLyt Solution are tightly sealed. Align the mark on the cap with the mark on the vial to prevent leakage.



Stability

Do not use CytoLyt Solution after the expiration date on the container label. If making multiple PreservCyt Solution vials from the same CytoLyt Solution sample container, be sure to make the slides before the expiration date marked on the sample container. Also, refer to storage requirements for cell preservation limits.

Handling/Disposal

Handle all chemical-containing materials carefully in accordance with safe laboratory practices.

WARNING: CytoLyt Solution is not intended for complete inactivation of microbes. Dispose of CytoLyt Solution according to guidelines for disposing of biologically hazardous materials. Observe appropriate biological safety precautions for handling fresh specimens.

The National Fire Protection Association (NFPA) is the expert authority that local fire departments and fire safety code enforcement authorities look to for fire safety standards and codes. Their codes are developed through a consensus standards development process approved by the American National Standards Institute. The NFPA codes are used as guidelines by most fire code enforcement agencies. Since these codes are guidelines, your local Authority Having Jurisdiction (AHJ) for fire code enforcement may make the final determination. The summary chart below is based upon guidelines for facilities protected by standard sprinkler systems. ⁽³⁾

The ThinPrep products NFPA ratings are listed in a table below this chart.

Use this chart to help you determine your maximum storage limits for flammable and combustible liquids.

Maximum Quantities of Flammable and Combustible Liquids in Laboratory Units Outside of Inside Liquid Storage Areas⁽⁴⁾														
Lab Unit Fire Hazard Class	Flammable & Combustible Liquid Class	NFPA Code	Quantities in Use						Quantities in Use and Storage					
			Max per 100ft ² (9.2m ²) of Lab Unit ⁽⁵⁾			Max Quantity per Lab Unit			Max per 100ft ² (9.2m ²) of Lab Unit ⁽⁵⁾			Max Quantity per Lab Unit		
			Gallons	Liters	Vials ⁽⁸⁾	Gallons	Liters	Vials ⁽⁸⁾	Gallons	Liters	Vials ⁽⁸⁾	Gallons	Liters	Vials ⁽⁸⁾
A (High)	I	45-2015	10	38	1900	480	1820	91,000	20	76	3800	480	1820	91,000
	I, II, IIIA	45-2015	20	76	3800	800	3028	151,400	40	150	7500	1600	6060	303,000
B⁽⁶⁾ (Moderate)	I	45-2015	5	19	950	300	1136	56,800	10	38	1900	480	1820	91,000
	I, II, IIIA	45-2015	10	38	1900	400	1515	75,750	20	76	3800	800	3028	151,400
C⁽⁷⁾ (Low)	I	45-2015	2	7.5	375	150	570	28,500	4	15	750	300	1136	56,800
	I, II, IIIA	45-2015	4	15	750	200	757	37,8520	8	30	1500	400	1515	75,750
D⁽⁷⁾ (Minimal)	I	45-2015	1	4	200	75	284	14,200	2	7.5	375	150	570	28,500
	I, II, IIIA	45-2015	1	4	200	75	284	14,200	2	7.5	375	150	570	28,500

Maximum Quantities of PreservCyt Solution (Class IC) That Can Be Stored per Fire Area⁽⁹⁾ Outside a Safety Flammable Cabinet					
Location		NFPA Code	Gallons	Liters	Vials ⁽⁸⁾
General Warehouse ⁽¹⁰⁾⁽¹²⁾⁽¹³⁾		30-2015	120	460	23,000
Liquid Warehouse ^(3,11)		30-2015	Unlimited	Unlimited	Unlimited
Office, to include Exam Rooms		30-2015	10	38	1900

Allowable Quantities of PreservCyt Solution That Can Be Stored in a Liquid Storage Room						
Location			NFPA Code	Gallons	Liters	Vials ⁽⁸⁾
Maximum allowable storage per ft ² in an inside storage room that is smaller than 150ft ² in size.			30-2015	5	19	950
Maximum allowable storage per ft ² in an inside storage room that is larger than 150ft ² and less than 500ft ² in size.			30-2015	10	38	1900

- (1) Solution classifications: PreservCyt – Class IC; CytoLyt – Class II; CellFyx – Class IB
- (2) This information is Hologic’s summary of the various regulations. To view the codes in their entirety, please refer to NFPA 30 and NFPA 45.
- (3) A Liquid Warehouse shall have a sprinkler system that complies with the appropriate system indicated in NFPA 30.
- (4) An Inside Liquid Storage Area is a storage room totally enclosed within a building and having no exterior walls.
- (5) A Laboratory Unit is the area surrounded by firewalls per NFPA 30 *Flammable and Combustible Liquids Code*.
- (6) Reduce quantities by 50% for B laboratory units located above the 3rd floor.
- (7) Reduce quantities by 25% for C and D laboratory units located on the 4th-6th floors of a building and reduce quantities by 50% for C and D laboratory units above the 6th floor
- (8) 20ml PreservCyt vials.
- (9) A Fire Area is the area of a building separated from the remainder of the building by construction having a fire resistance of at least 1-hour and having all communicating openings properly protected by an assembly having a fire resistance rating of at least 1-hour per NFPA 30 *Flammable and Combustible Liquids Code*.

- (10) Allowable quantities in a warehouse can be increased with a sprinkler system rated higher than standard systems.
- (11) A Liquid Warehouse is a separate, detached building or attached building used for warehousing-type operations for liquids.
- (12) Quantities are permitted to be increased 100% where stored in approved flammable liquids storage cabinets.
- (13) Quantities are permitted to be increased 100% in buildings equipped throughout with an automatic sprinkler system installed in accordance with NFPA13, Standard for the Installation of Sprinkler Systems.

This table lists the NFPA ratings for all the ThinPrep products.

ThinPrep Product	Health Hazard	Flammability Hazard	Instability Hazard	Specific Hazard
ThinPrep PreservCyt Solution	2	3	0	N/A
ThinPrep CytoLyt Solution	2	2	0	N/A
ThinPrep CellFyx Solution	2	3	0	N/A
ThinPrep Rinse Solution	0	0	0	N/A
ThinPrep Bluing Solution	0	0	0	N/A
ThinPrep Rinse II Solution	2	3	0	N/A
ThinPrep Bluing II Solution	0	0	0	N/A
ThinPrep Stain EA Solution	2	3	0	N/A
ThinPrep Stain Orange G Solution	2	3	0	N/A
ThinPrep Nuclear Stain	2	0	0	N/A

ThinPrep® Solutions Shipping Requirements *

Scope:

These requirements include shipping:

- Biological specimens (patient specimens) in ThinPrep® solutions
- Biological specimens in solutions other than ThinPrep® solutions
- Biological specimens not in solutions
- ThinPrep® PreservCyt™ Solution without biological specimens
- ThinPrep® CytoLyt™ Solution without biological specimens

Note: Shippers of Hazardous Materials or Dangerous Goods must be trained according to the various Hazardous Materials/Dangerous Good regulations

A. Shipping Requirements when shipping patient samples in ThinPrep PreservCyt Solution only – Ambient Temperature:

1. Patient samples / biological substances (pathogens) contained ThinPrep PreservCyt Solution are neutralized or inactivated by the solution and as such no longer pose a health risk. (For further information regarding this, refer to the ThinPrep 2000 or ThinPrep 5000 Operators' Manual).
2. Materials that have been neutralized or inactivated are exempt from the Category B Class 6, Division 6.2 requirements.
3. Solutions that contain neutralized or inactivated pathogens, and meet the criteria of one or more of the other hazards risks, must be shipped according to the shipping requirements for that hazard risk(s).
4. ThinPrep PreservCyt Solution is a Flammable liquid when shipped domestic or international. Therefore, follow the instructions in Section C below, Shipping ThinPrep® PreservCyt™ Solution Only (such as from a laboratory to a physician).

B Shipping Biological Specimens in Solutions (other than ThinPrep PreservCyt Solution) or Without Solutions

Notes:

When biological specimens are shipped in a solution of a quantity of 30 ml or less and are packed in accordance with these guidelines, no further requirements in the Hazardous Materials (Dangerous Goods) Regulations need be met. However, training is recommended.”¹

Definitions:

- Biological Substance, Category B: Materials containing or suspected to contain infectious substances that do not meet Category A criteria. IATA Dangerous Goods regulations were revised with an effective date of January 1, 2015. Note: The term “diagnostic specimen” has been replaced with “biological substance, Category B”
- Exempt specimens: Specimens that with the minimal likelihood that pathogens are present (fixed tissue, etc.)

* These instructions are Hologic's interpretation of the various regulations as of the effective date. However, Hologic will not be responsible for any non-conformance to the actual regulations.

Shipping Requirements Category B or Exempt ¹ – Ambient Temperature:

1. Packaging must consist of three components
 - a. a primary receptacle, leak proof
 - b. secondary packaging, leak proof
 - c. a rigid outer packaging

NOTES:

- FedEx will not accept clinical samples or diagnostic specimens packaged in FedEx envelopes, FedEx tubes, FedEx Paks, or FedEx Boxes, Styrofoam boxes, plastic bags, or paper envelopes.
- FedEx will accept clinical samples in FedEx Clinical Paks, FedEx Medium Clinical Boxes or FedEx Large Clinical Boxes.²

2. The primary receptacle cannot contain more than 1L of a liquid substance (500 ml if using FedEx).
3. If multiple fragile primary receptacles are placed in a single secondary packaging, they must be either individually wrapped or separated to prevent contact between them.
4. Absorbent material must be placed between the primary receptacle and the secondary packaging. The absorbent material (cotton balls, cellulose wadding, absorbent packets, paper towels) must be in sufficient quantity to absorb the entire contents of the primary receptacle(s) so that any release of the liquid substance will not compromise the integrity of the cushioning material or the outer packaging.
5. The outer packaging must not contain more than 4L or 4kg of material. This quantity excludes ice, dry ice, or liquid nitrogen when used to keep specimens cold.
6. An itemized list of contents must be enclosed between the secondary packaging and the outer packaging.
7. The packaging must successfully pass a 4 ft. drop test (Section 6.6.1 IATA regulations).
8. The UN3373 mark must be displayed on the external surface of the outer packaging (one surface of the outer packaging must have a minimum dimension of 100 mm x 100 mm FedEx minimum is 7"x 4"x 2") on a background of a contrasting color and must be clearly visible and legible. The mark must be in the form of a diamond with each side having a length of at least 50 mm. Lettering must be at least 6mm high.
9. The proper shipping name "Biological Substance, Category B" in letters at least 6mm high must be marked on the outer package adjacent to the diamond shaped UN3373 mark.

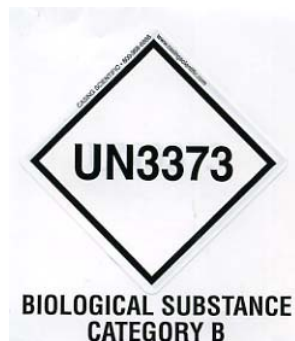

10. If using FedEx, the FedEx USA Airbill, Section 6, Special Handling must be completed with dangerous goods/dry ice information:

Does this shipment contain dangerous goods?

YES- Shipper's Declaration not required

11. The outer container of all diagnostic/clinical specimen packages must display the following:

- a. Sender's name and address
- b. Recipient's name and address
- c. The words "Biological Substance, Category B"
- d. The UN 3373 label

Shipping Requirements Category B or Exempt¹ – Frozen or Refrigerated Specimens:

NOTE: FedEx defers to IATA regulations for the shipping of refrigerated or frozen diagnostic specimens.²

Follow all packaging directions for Category B or Exempt – Ambient Temperature plus:

1. Place ice or dry ice outside of the secondary packaging. Interior supports must be provided to secure the secondary packaging in the original position after the ice or dry ice has dissipated. If ice is used, the outside packaging or overpack must be leak proof. If dry ice is used, the packaging must be designed and constructed to permit the release of CO² gas to prevent a buildup of pressure that could rupture the packaging.

2. Always affix the Class 9, UN 1845 dry ice label as well as the UN 3373, Biological Substance, Category B label to these shipments

3. If using FedEx, the FedEx USA Airbill, Section 6, Special Handling must be completed with dangerous goods/dry ice information:

Does this shipment contain dangerous goods?

YES- Shipper's Declaration not required

Enter kg of dry ice used (if applicable)

4. The outer container of all diagnostic/clinical specimen packages must display the following:

- a. Sender's name and address
- b. Recipient's name and address
- c. The words "Biological Substance, Category B"
- d. The UN 3373 label
- e. Class 9 label, including UN 1845, and net weight if packaged with dry ice

C Shipping ThinPrep[®] PreservCyt[™] Solution Only (such as from a laboratory to a physician)

Domestic Ground Shipments - Limited Quantities:

Notes:

ThinPrep® PreservCyt™ Solution is classified as a Class 3 Flammable liquid, assigned to Packing Group III (PG III).

49 CFR 173.150 (Limited Quantities) allows ThinPrep® PreservCyt™ Solution in vials to be shipped in Limited Quantities when shipped via ground transportation in a sturdy box. The total volume in a package cannot exceed 5 liters or weigh more than 30 kg (66 lbs). Limited Quantities are exempt from labeling requirements.

Limited Quantity domestic ground shipping recommendations:

1. ThinPrep® PreservCyt™ Solution must be shipped in the vials.
2. Place the vials in a good quality cardboard box, such as the ThinPrep® box that holds 250 vials. Pack vials in a manner (adding protective packing material as necessary) as to limit movement of individual vials.
3. Mark the package as “Flammable liquids, n.o.s., (Methanol Solution), 3, UN1993, Ltd. Qty.” add orientation arrows on the ends, and the Limited Quantity label:

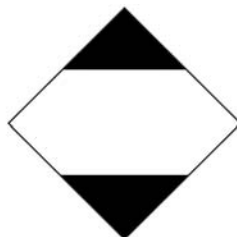

4. Print “UN1993, Flammable liquids, n.o.s., (Methanol Solution), 3, PG III, Ltd. Qty.” on the Shipping papers.

Domestic Ground Shipments - Other than Limited Quantities:

When shipping packages in excess of “Limited Quantity” amounts:

1. Do not include “Ltd Qty” in the wording on the package or on the Shipping papers as indicated in c and d above.
2. Affix a Class 3 “Flammable Liquid” hazard label to the outer package in close proximity of the wording described in “C” above. See the example of the label on the last page of these recommendations.
3. Mark the package as “Flammable liquids, n.o.s., (Methanol Solution), 3, UN1993, Net Qty.”

Domestic Air Shipments:

In addition to 1 and 2 above in Domestic Ground Shipments – Other than Limited Quantities, the following are recommendations for domestic air shipments:

3. Maximum allowable package sizes are:
 - i. Sixty (60) liters (3000-vials) for passenger aircraft, and
 - ii. Two hundred twenty (220) liters (11,000-vials) for cargo aircraft.

4. Single packages containing more than sixty (60) liters (3000-vials) of total product must be clearly marked "FOR CARGO AIRCRAFT ONLY".
5. The vials must be shipped in United Nations (UN) certified 4G packaging for any quantity in an aircraft. (e.g., ThinPrep® PreservCyt™ Solution 250-vial box or equivalent.)
6. A Class 3 "Flammable Liquid" label must be affixed to the outer package near the words "Flammable liquids, n.o.s., (Methanol Solution)".



All Domestic Shipments:

The following are recommendations for all domestic ground and air shipments:

1. If the ThinPrep® PreservCyt™ Solution is shipped in a package also containing non-hazardous material, the hazardous material must be listed first, or be printed in a contrasting color (or highlighted) to differentiate it from the non-hazardous material.
2. The total volume of ThinPrep® PreservCyt™ Solution and the number of vials must appear on the shipping papers.

International Ground Shipments - Limited Quantities:

When shipping internationally, ThinPrep® PreservCyt™ Solution is classified with a primary hazard of Class 3 (Flammable Liquid), and with a secondary hazard of Class 6.1 (Toxic). It is assigned to PG III.

The reference used for the international ground recommendations is the *ADR - European Agreement Concerning the International Carriage of Dangerous Good by Road* (United Nations). A "Limited Quantity" is defined as a package containing a maximum net quantity of 5-liters and not weighing more than 20 kg (40 lbs). The recommendations for international ground shipments are as follows:

1. ThinPrep® PreservCyt™ Solution must be shipped in the vials.
2. Place the vials in a good quality cardboard box, such as the Cytyc box that holds 250 vials. Pack vials in a manner (adding protective packing material as necessary) as to limit movement of individual vials.
3. Mark the package with "UN1992, Flammable liquids, toxic, n.o.s., (Methanol Solution), 3, 6.1, PGIII Ltd. Qty" orientation arrows on the ends and the Limited Quantity label that has a "Y" on it.



4. The shipping papers should include all the information indicated in "3" above.

International Ground Shipments – Other than Limited Quantities:

1. Do not include "Ltd Qty" in the wording on the package or on the Shipping papers as indicated in c and d above.
2. Affix both a Class 3 "Flammable Liquid" label and a secondary Class 6.1 "Toxic" label to the package adjacent to the markings. (Copies of the labels can be found on the last page of this document.)



Class 6.1 "Toxic" secondary hazard label.

3. Mark the package with "UN1992, Flammable liquids, toxic, n.o.s., (Methanol Solution), 3, 6.1, PG III, Net Qty".

International Air Shipments:

The references used for the International Air recommendations are: In addition to a and b above in International Ground Shipments, the following are the recommendations for international air shipments:

1. Maximum allowable package sizes are:
 - i. Sixty (60) liters (3000-vials) for passenger aircraft, and
 - ii. Two hundred twenty (220) liters (11,000-vials) for cargo aircraft.
2. Packages containing more than sixty (60) liters of product must be clearly marked "FOR CARGO AIRCRAFT ONLY"
3. The vials must be shipped in United Nations (UN) certified 4G packaging for any quantity in an aircraft. (e.g., ThinPrep® PreservCyt™ Solution 250-vial box or equivalent.) Pack vials in a manner (adding protective packing material as necessary) as to limit movement of individual vials.
4. Limited Quantity exemption can only be used if the package has a maximum net quantity of 2-liters.
5. Packaging manufacturer's specifications markings are not required when shipping Limited Quantity.
6. Mark the package with "UN1992, Flammable liquids, toxic, n.o.s., (Methanol Solution), 3, 6.1, PGIII, Net. Qty".
7. When a "Cargo Aircraft Only" marking is required, it must be affixed on the same package surface and near the hazard labels.
8. The shipper is responsible for the completion of a "Shipper's Declaration for Dangerous Goods" form.

D. Shipping ThinPrep® CytoLyt™ Solution Only (such as from a laboratory to a physician)

Domestic Ground Shipments:

ThinPrep® CytoLyt™ Solution has a flash point of 109° F. For domestic ground transportation only, a flammable liquid with a flashpoint at or above 100° F that does not meet the definition of any other hazard class may be reclassified as a combustible liquid. As such, ThinPrep® CytoLyt™ Solution, shipped via ground, is exempt from the requirements of the DOT Hazardous Materials Regulations.

Domestic Air Shipments:

When shipping ThinPrep® CytoLyt™ Solution via air, follow the Domestic Air Shipments recommendations for Shipping ThinPrep® PreservCyt™ Solution Only that can be found in Section C of this document.

International Ground and Air shipments:

When shipping ThinPrep® CytoLyt™ Solution via ground or air, follow the International Ground or Air Shipments recommendations for Shipping ThinPrep® PreservCyt™ Solution Only guidelines that can be found in Section C of this document.

E. Shipping ThinPrep® CytoLyt™ Solution With Patient Sample (such as from a physician to a laboratory)

Domestic Shipments:

ThinPrep® CytoLyt™ Solution containing a patient sample is classified as a Biological Substance, Category B. Follow the recommendations in Section B of this document.

International Shipments:

ThinPrep® CytoLyt™ Solution containing a patient sample is classified as a Biological Substance, Category B. Follow the recommendations in Section B of this document.

References:

- 49 CFR 100 to 185, *Transportation*
- *Dangerous Goods Regulations*, 56th Edition, 2015, International Air Transportation Association (IATA)
- International Civil Aviation Organization's (ICAO) *Technical Instructions for the Safe Transport of Dangerous Goods by Air*

Foot Notes:

1. See Packing Instruction 650 in the IATA *Dangerous Goods Regulations*
2. FedEx Document 33539PL: "Packaging Clinical Samples" and "Packaging UN 3373 Shipments"



Index

B

bloody fluid 20

body fluids 20

C

cell transfer 4

collection fluids 31

CytoLyt Solution

 composition 5

 handling/disposal 6

 packaging 5

 stability 6

 storage requirements 5

CytoLyt Solution wash 15

D

Dithiothreitol (DTT) 19

F

filter membrane 4

fine needle aspirates 5, 17

FirstCyte Ductal Lavage 22

fixation 13

fluid specimens 6

G

glacial acetic acid 32

M

mucoïd specimens 5, 14, 18, 29



P

Plasma-Lyte 6

Polysol 6

PreservCyt Solution

 composition 2

 handling/disposal 3

 packaging 2

 Stability 3

 storage requirements 2

 transportation 2

R

red blood cells 5

Required Materials 3

S

saline solution 32

Sample is Dilute 27, 29

Sequence 1 21, 27, 29

Sequence 2 17, 21, 22, 27, 28, 30

Sequence 3 19, 29

staining 13

superficial specimen 6, 21

T

troubleshooting 26, 32

U

UroCyt specimens 23

UroCyt Urine Collection Kit 20

V

vial cap, align 2

Service Information

Service Information



Service Information

Mailing Address

Hologic, Inc., 250 Campus Drive, Marlborough, MA 01752 USA

Remittance Address

Hologic, Inc., P.O. Box 3009, Boston, MA 02241-3009 USA

Business Hours

Hologic's business hours are 8:30 a.m. to 5:30 p.m. EST Monday through Friday excluding holidays.

Customer Service

To order products, and place or amend standing orders, call Customer Service at 1-800-442-9892 or 1-508-263-2900 during business hours or fax your order to the attention of Customer Service at 1-508-229-2795.

To order service contracts call Technical Support at 1-800-442-9892 or 1-508-263-2900 during business hours.

Technical Support

Technical service and cytology application representatives are available to answer questions about your ThinPrep® 2000 System and related application issues at 1-800-442-9892 or 1-508-263-2900 from 7:00 a.m. to 7:00 p.m. Eastern Time Monday through Friday excluding company holidays.

Returns

For returns related to warranty issues, please contact Technical Support at 1-800-442-9892 or 1-508-263-2900 and for questions regarding any other type of return, please contact Customer Service.



SERVICE INFORMATION

This page intentionally left blank.

Ordering Information

Ordering Information



Ordering Information

Mailing Address

Hologic, Inc., 250 Campus Drive, Marlborough, MA 01752 USA

Remittance Address

Hologic, Inc., P.O. Box 3009, Boston, MA 02241-3009 USA

Business Hours

Hologic's business hours are 8:30 a.m. to 5:30 p.m. EST Monday through Friday excluding holidays.

Ordering Information

To order products, and place or amend standing orders, call Customer Service at 1-800-442-9892 or 1-508-263-2900 during business hours or fax your order to the attention of Customer Service at 1-508-229-2795.

To order service contracts call Technical Support at 1-800-442-9892 or 1-508-263-2900 during business hours.

Terms

Net 30 days.

Shipping

All prices are F.O.B. Marlborough, Massachusetts, USA. All in-stock items are shipped on the next business day after the order is placed via UPS ground delivery. Second day and overnight delivery are available upon request.

PreservCyt® Solution and CytoLyt® Solution are considered hazardous substances and air freight companies will not guarantee second day or overnight delivery. Please try to order your solutions in advance.

Technical Support

Technical service and cytology application representatives are available to answer questions about your ThinPrep® 2000 System and related application issues at 1-800-442-9892 or 1-508-263-2900 from 8:30 a.m. to 5:30 p.m. Eastern Time Monday through Friday excluding company holidays.

Returns

Hologic does not accept returns for the following products: PreservCyt Solution and CytoLyt Solution. All non-returnable items are guaranteed to ship from Hologic, Marlborough, Massachusetts at least six months prior to the expiration date on the product.

For returns on all other supplies, please call Customer Service at 1-800-442-9892 or



ORDERING INFORMATION

1-508-263-2900 to obtain a Return Goods Authorization number. Hologic will not accept any returned items without this number.

For returns related to warranty issues, please contact Technical Support at 1-800-442-9892 or 1-508-263-2900 and for questions regarding any other type of return, please contact Customer Service.

Supplies for the ThinPrep® Pap Test (Gynecologic) Application

Item	Description	Order Number
ThinPrep Pap Test Kit	<p>Materials for 500 ThinPrep Pap Tests</p> <p>Contains:</p> <ul style="list-style-type: none"> 500 Vials of PreservCyt Solution for use with the ThinPrep Pap Test 500 ThinPrep Pap Test Filters (Clear) 500 ThinPrep Microscope Slides 500 Collection Devices <p>Configured with:</p> <ul style="list-style-type: none"> 500 Broom-like Collection Devices 500 Cytobrush/Spatula Collection Devices 	<p>70096-001</p> <p>70096-003</p>
ThinPrep Pap Test Kit (for use with the ThinPrep Imaging System)	<p>Materials for 500 ThinPrep Pap Tests</p> <p>Contains:</p> <ul style="list-style-type: none"> 500 Vials of PreservCyt Solution for use with the ThinPrep Pap Test 500 ThinPrep Pap Test Filters (Clear) 500 ThinPrep Imaging System Microscope Slides 500 Collection Devices <p>Configured with:</p> <ul style="list-style-type: none"> 500 Broom-like Collection Devices 500 Cytobrush/Spatula Collection Devices 	<p>70662-001</p> <p>70662-003</p>

ORDERING INFORMATION



Item	Description	Order Number
ThinPrep Pap Test Physician Office Kit	Contains: 500 Vials of PreservCyt Solution for GYN	
	Configured with: 500 Broom-like Collection Devices	70136-001
	500 Cytobrush/Spatula Collection Devices	70136-002
ThinPrep Pap Test Laboratory Kit	Contains: 500 ThinPrep Pap Test Filters (Clear)	
	500 ThinPrep Microscope Slides	70137-001
ThinPrep Pap Test Laboratory Kit (for use with the ThinPrep Imaging System)	Contains: 500 ThinPrep Pap Test Filters (Clear) 500 ThinPrep Imaging System Microscope Slides	70664-001
Broom-Like Collection Devices Kit	Contains: 500 Broom-like Collection Devices (20 bags of 25 devices)	70101-001
Cytobrush/Plastic Spatula Kit	Contains: 500 Cytobrush/Spatula Collection Devices (20 bags of 25 device pairs)	70124-001



ORDERING INFORMATION

Supplies for the ThinPrep 2000 Processor

Item	Description	Order Number
Filter Cap Assembly	1 Filter Cap with O-Rings Installed	71103-001
O-Rings for Filter Cap	1	50038-008
Waste Filter	1	50248-001
ThinPrep 2000 System Operator's Manual	1	MAN-01408-001
Waste Bottle Assembly (includes: cap, tubing, filter & connectors)	1	74002-004
Waste Tubing Replacement Kit	2 Pre-cut tubes for waste tubing replacement	74023-001, ASY-10894
High Vacuum Silicone Grease	150g tube	MTL-00485
Fixative Vials	1 vial	70129-001
Multi-Mix [®] Racked Vortexor	1	*
Sealed Cylinder	1	02559-001
Base Liners	Package of 4	70280-001

* Order number depends upon specific power requirements for each country. Contact Hologic Customer Service.



Supplies and Solutions for Non-Gynecologic Applications

Item	Description	Order Number
PreservCyt Solution	20 ml in a 2 oz. vial 50 vials/box	70787-002
	946 ml in a 32 oz. bottle 4 bottles/box	70406-002
CytoLyt Solution	946 ml in a 32 oz. bottle 4 bottles/box	70408-002
	30 ml in a 50 ml centrifuge tube 80 tubes/box	0236080
	30 ml in a 120 ml cup 50 cups/box	0236050
Dispenser Pump	1 Pump for CytoLyt Quart (32 oz.) Bottle Dispenses approximately 30 ml.	50705-001
Non-Gyn Filters (Blue)	Box of 100	70205-001
ThinPrep UroCyte® System Kit	100 ThinPrep UroCyte Filters (Yellow) 100 UroCyte microscope slides 2 PreservCyt Vial 50-packs 4 bottles of CytoLyt Solution (946 ml in a 32 oz. bottle)	71003-001
ThinPrep UroCyte Filters (Yellow)	100 filters per tray	70472-001
ThinPrep UroCyte Microscope Slides	100 slides per box	70471-001
ThinPrep UroCyte PreservCyt Cups	50 cups per case	70991-001
ThinPrep UroCyte Urine Collection Kit	20 kits per case	70908-001
Arc-less slides (for IHC stains)	Box, 1/2 gross	70126-002
Non-Gyn slides	100 slides per box	70372-001



ORDERING INFORMATION

Injection Solutions Available from Baxter Healthcare Corporation 1-800-933-0303

Plasma-Lyte® A Injection pH 7.4	500 mL	2B2543
Plasma-Lyte® A Injection pH 7.4	1000 mL	2B2544



Safety Data Sheets

CytoLyt® Solution

PreservCyt® Solution

The Safety Data Sheet (SDS) for each solution may be requested from Hologic Technical Support, or found on-line at www.hologicsds.com.



SAFETY DATA SHEETS

This page intentionally left blank.

Hologic® ThinPrep® 20000 Processor | Operator's Manual



Hologic, Inc.
250 Campus Drive
Marlborough, MA 01752 USA
+1-508-263-2900
www.hologic.com



Hologic Ltd.
Heron House, Oaks Business Park
Crewe Road, Wythenshawe
Manchester, M23 9HZ, UK
+44 (0)161 946 2206



MAN-01408-001 Rev. 009